

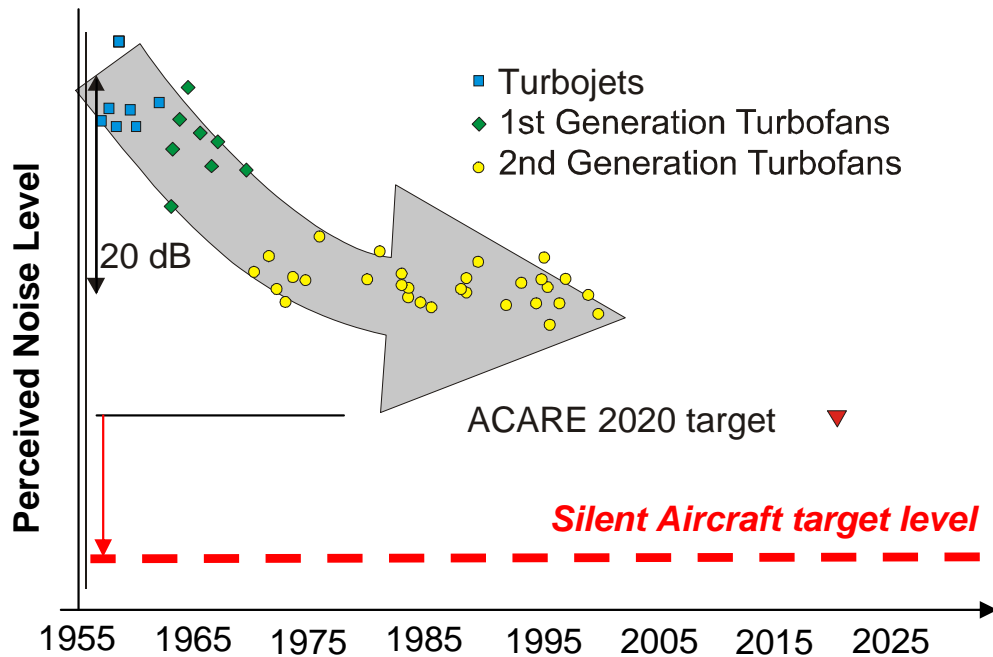

Towards a Silent Aircraft

**Ann Dowling and Tom Hynes
Department of Engineering
University of Cambridge**

The Challenge



- Starting with a blank piece of paper, can one design a mid-range passenger aircraft that is inaudible* outside a typical airport?

* noise reduced to the background level in a daytime urban environment

The Scale of the Challenge

**Demo: Scale of the Problem
10 vs. 1 hairdryer**

10 to 5



10 to 1



The Scale of the Challenge

- **Sound Pressure**

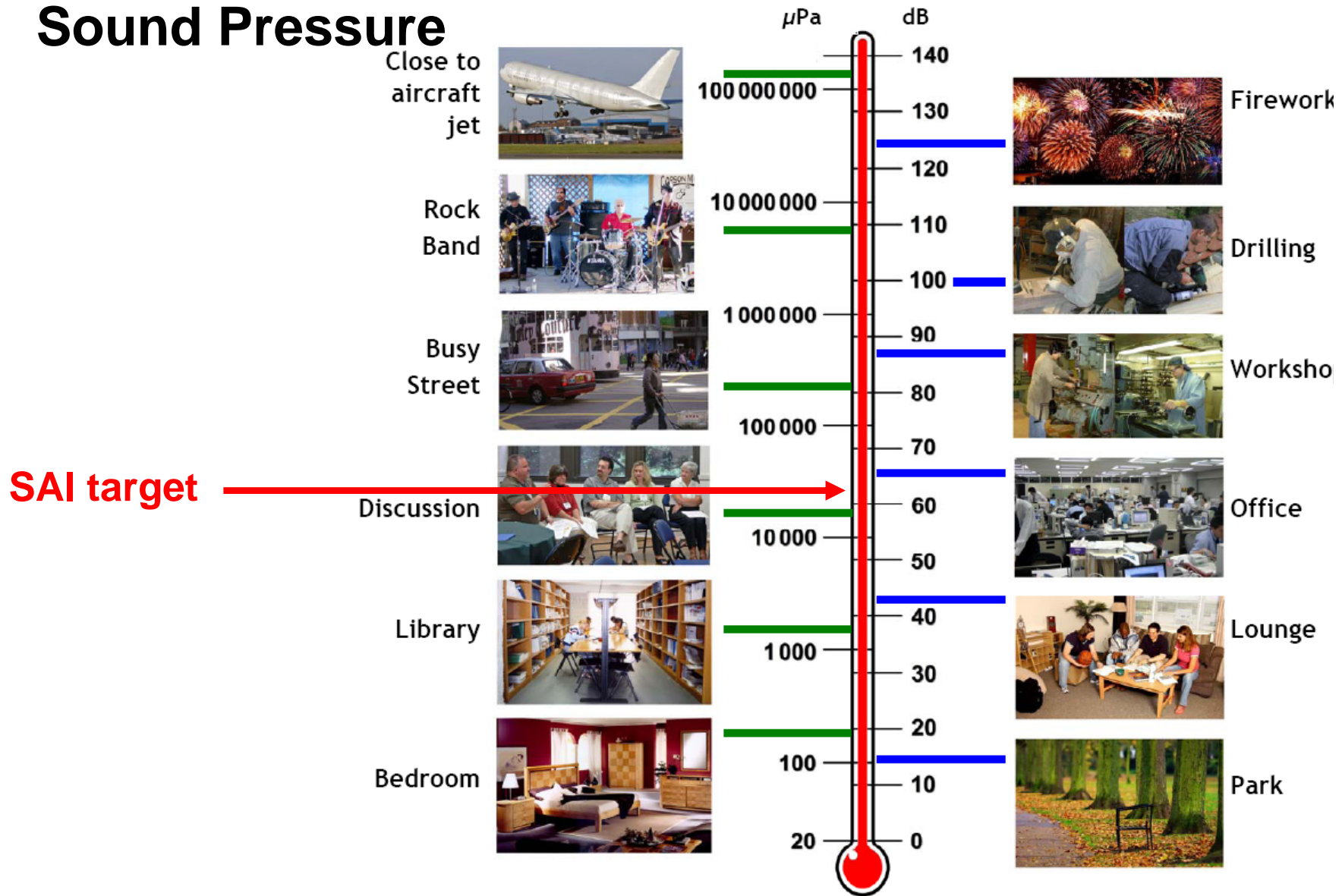

The Scale of the Challenge

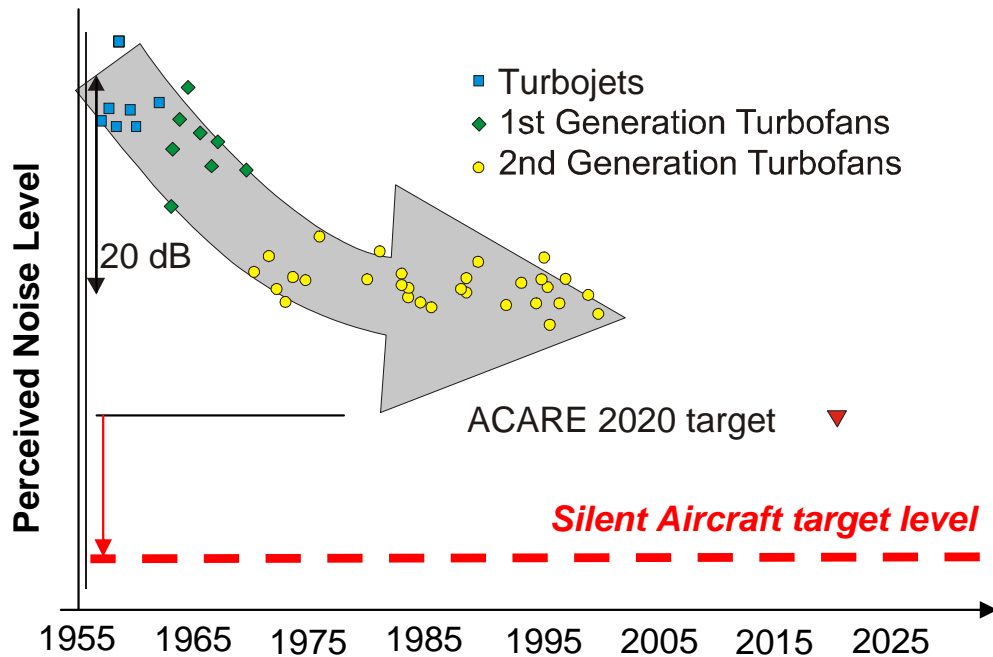

- This means a reduction of about 25dB compared with current aircraft
- Acoustic energy reduced to about 0.3% of current levels

Current aircraft
then 25dB reduction



The Scale of the Challenge

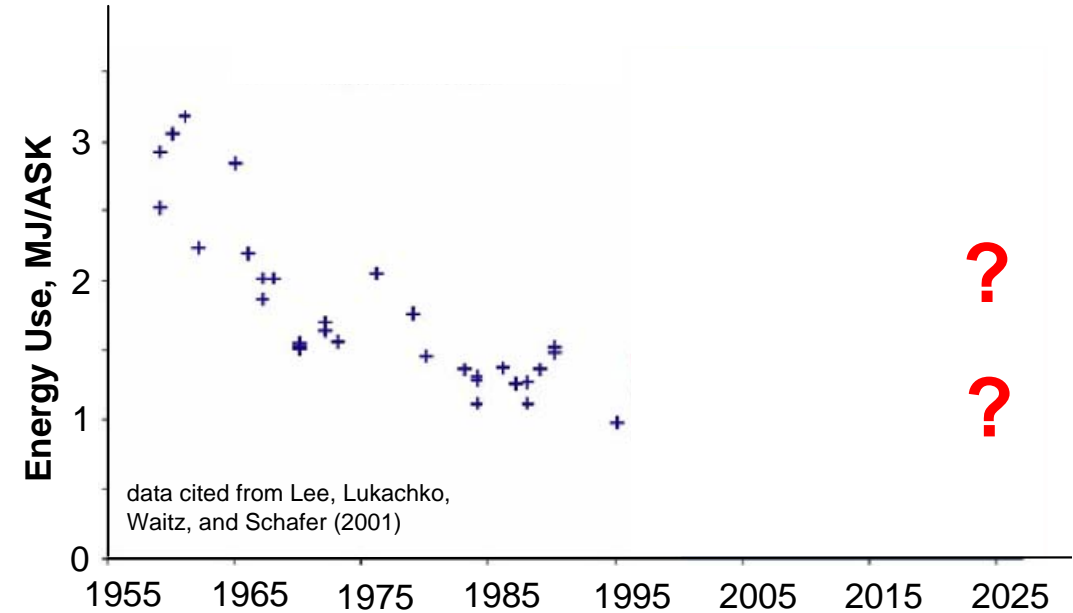
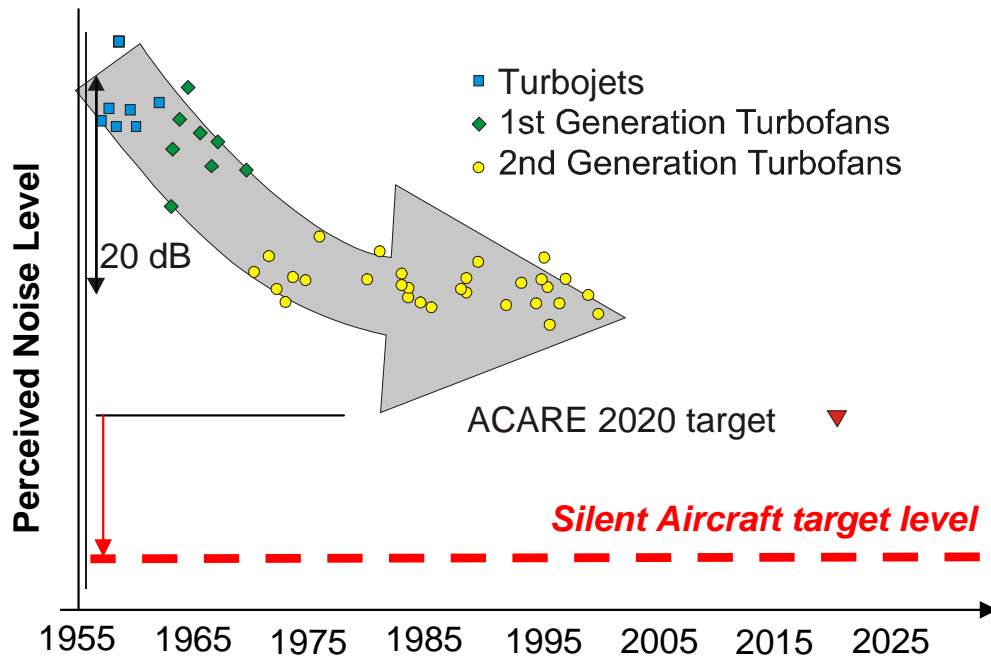

- This means a reduction of about 25dB compared with current aircraft
- Acoustic energy reduced to about 0.3% of current levels
- If it is possible to design such a 'Silent' Aircraft how does its fuel burn and emissions compare to existing and next generation aircraft ?

The Silent Aircraft Initiative

- **40 University of Cambridge and MIT researchers**
- **Many partners including Boeing, Rolls-Royce, Marshalls, NASA, NATS, CAA, airline and airport operators, HACAN, B&K, Lochard, Cranfield University**



Aircraft Noise Sources

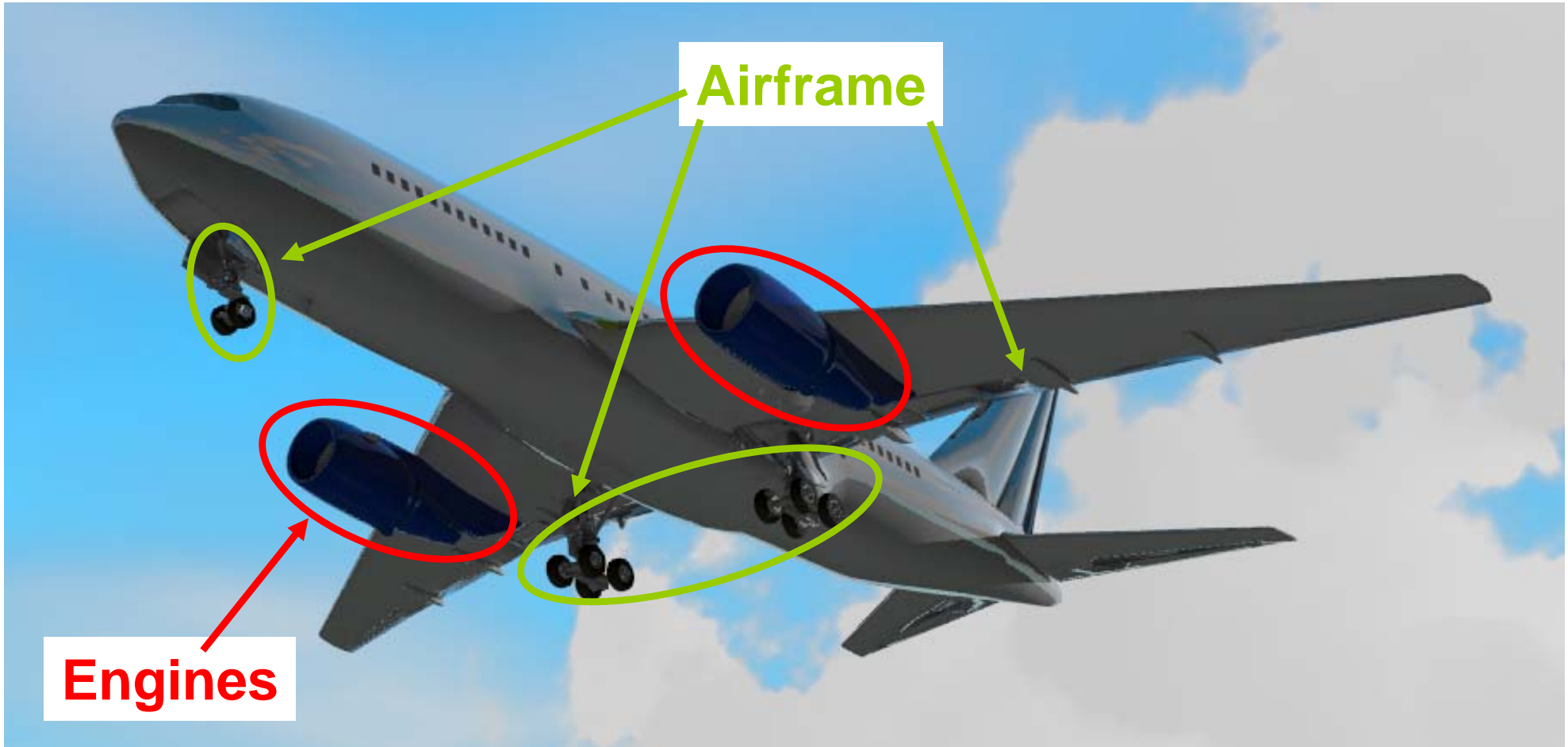

Noise Source Detection

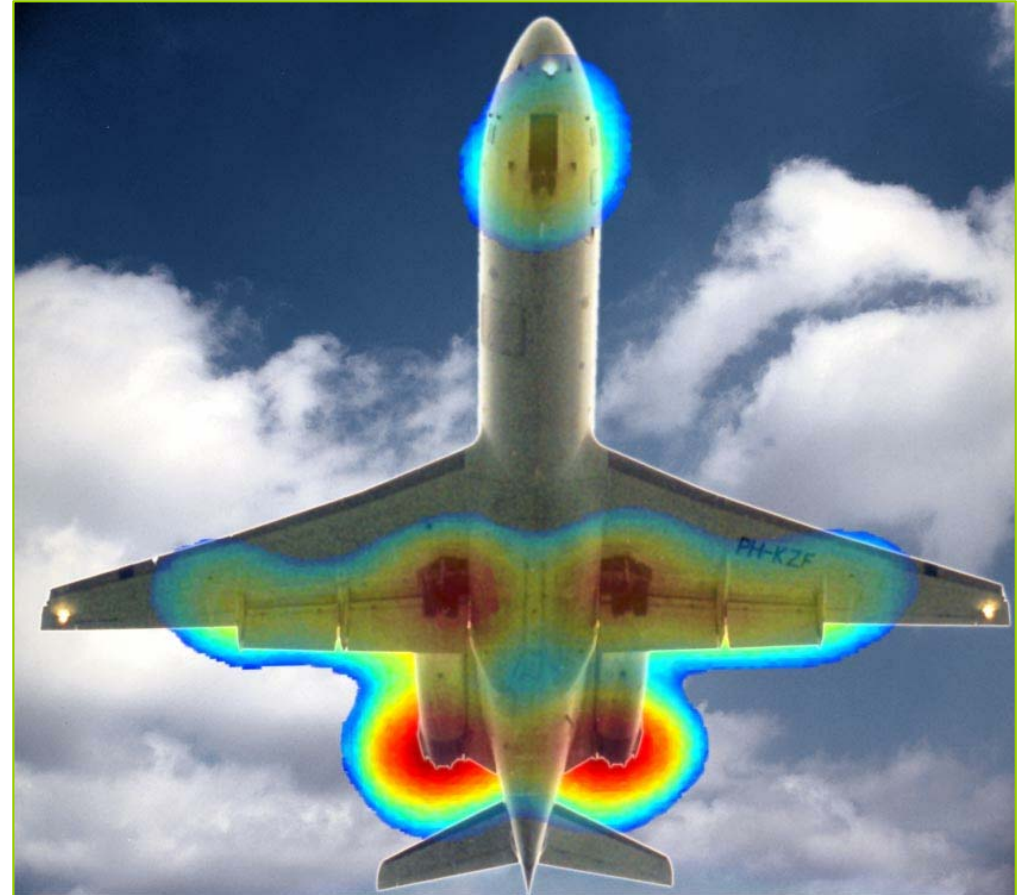
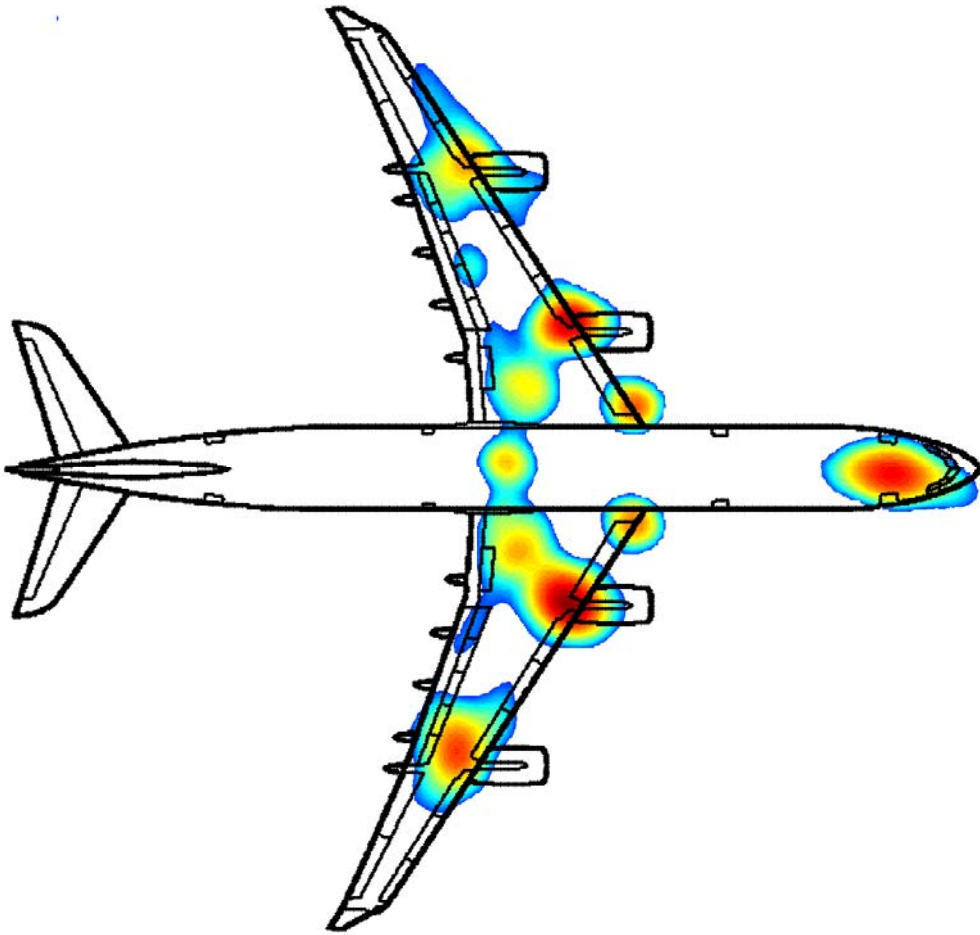

Courtesy NLR

Noise sources on conventional aircraft

- **Take-off**



- **Approach**



Photo Copyright © Paul Barbee

Level of current aircraft
(of about 250 passengers)

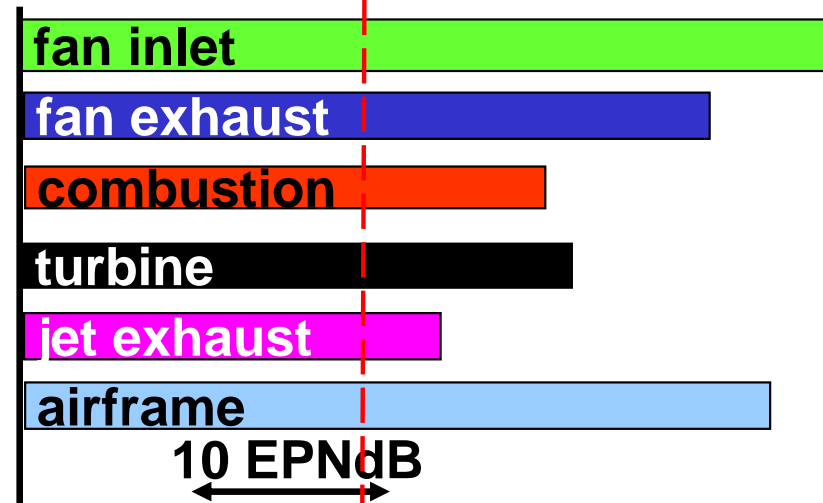
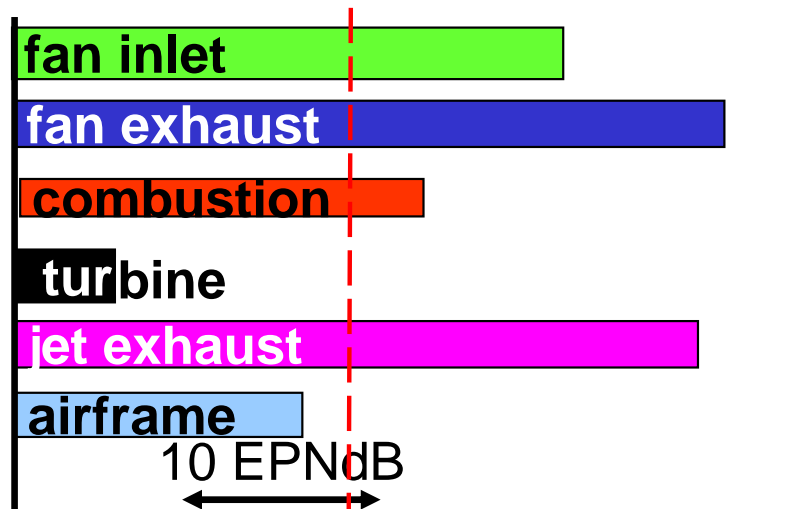

target level

What can we do about them?

- **Take-off**



- **Approach**



Photo Copyright © Paul Barbee

AIRLINERS.NET

- Greater integration of the airframe and engines
- Using the airframe
 - to shield the engine noise
 - to provide space for more extensive acoustic liners
- Operations for low noise considered as part of the design
 - throughout climb: optimise power settings
 - approach: less rapid 60ms^{-1} ,
 - larger angle 3.9° ,
 - land further down the runway
- A design without flaps or slats
- Lower jet noise

What can we do about them?

- **Take-off**



- **Approach**

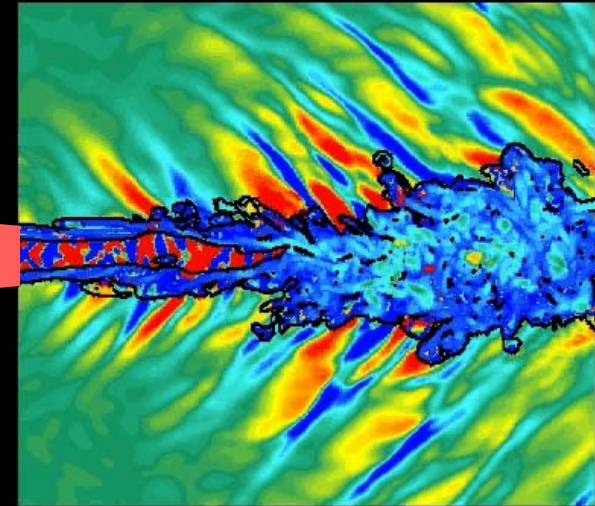
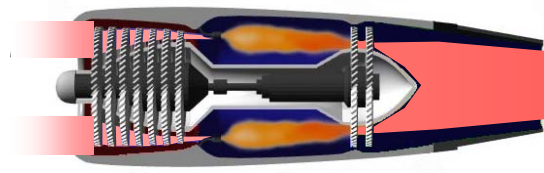

Photo Copyright © Paul Barbee

AIRLINERS.NET

- Greater integration of the airframe and engines
- Using the airframe
 - to shield the engine noise
 - to provide space for more extensive acoustic liners
- Operations for low noise considered as part of the design
 - throughout climb: optimise power settings
 - approach: less rapid 60ms^{-1} ,
 - larger angle 3.9° ,
 - land further down the runway
- A design without flaps or slats
- Lower jet noise ?

Lower jet noise



Animation courtesy Jonathan Freund,
University of Illinois Urbana-Champaign

Lower jet noise

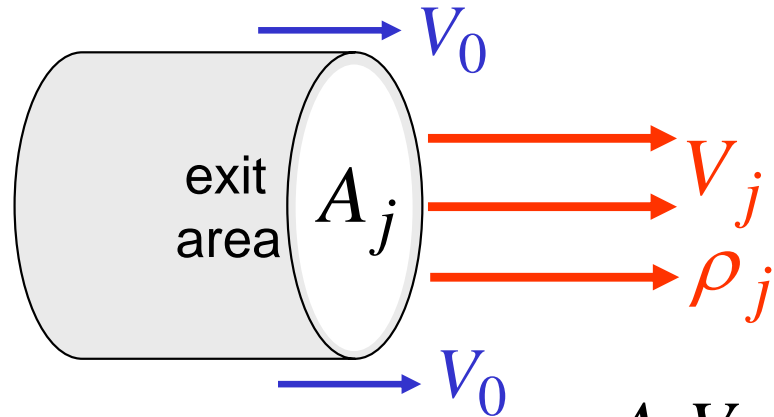

Jet mixing noise depends mainly on jet velocity

- Engine net thrust = $\rho_j A_j V_j (V_j - V_0)$
- Lighthill's jet noise theory says acoustic power proportional to

$$\rho_j (V_j - V_0)^8 A_j / c_0^5$$

Lower jet noise

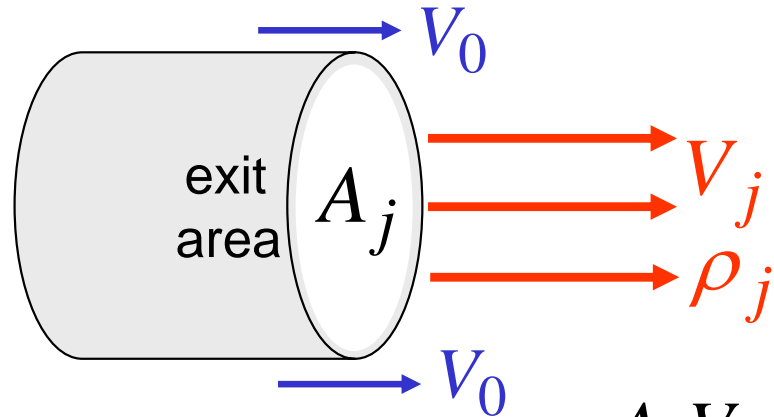

Jet mixing noise depends mainly on jet velocity

- Engine net thrust = $\rho_j A_j V_j (V_j - V_0)$
- Lighthill's jet noise theory says acoustic power proportional to
$$\rho_j (V_j - V_0)^8 A_j / c_0^5$$
- Significant jet noise reduction is possible with a large exhaust area.
- What minimum jet area meets our noise target?

Lower jet noise

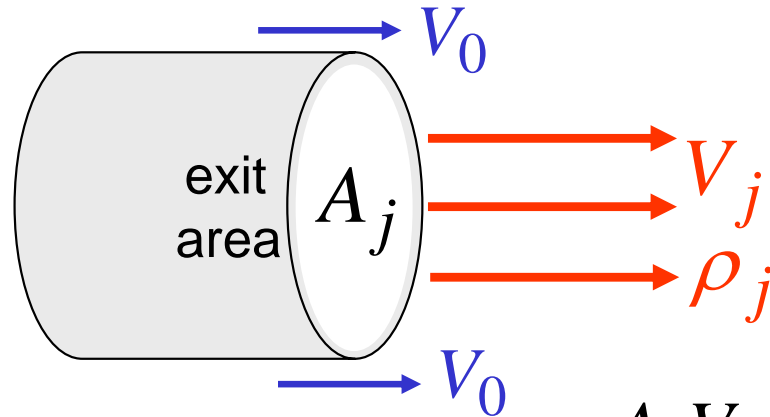

Jet mixing noise depends mainly on jet velocity

- Engine net thrust = $\rho_j A_j V_j (V_j - V_0)$
- Lighthill's jet noise theory says acoustic power proportional to
$$\rho_j (V_j - V_0)^8 A_j / c_0^5$$
- Significant jet noise reduction is possible with a large exhaust area.
- What minimum jet area meets our noise target?
- Depends on operations: with an optimised climb trajectory and power settings this needs BPR ~ **18.3:1**

Optimisation for low noise

Dan Crichton

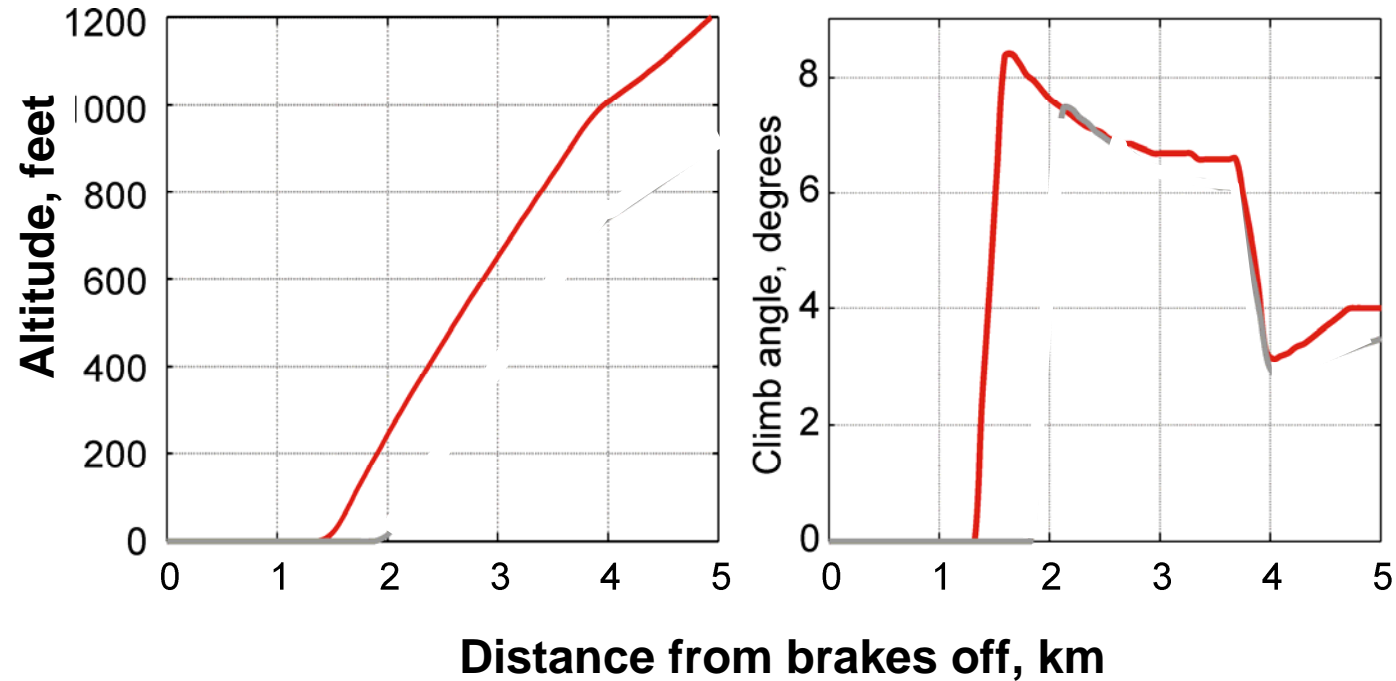

Optimised trajectory

Lower jet noise



Meeting our jet noise goal leads to approximately 2 times the area even of next generation engines

How can these engines give good cruise efficiency?

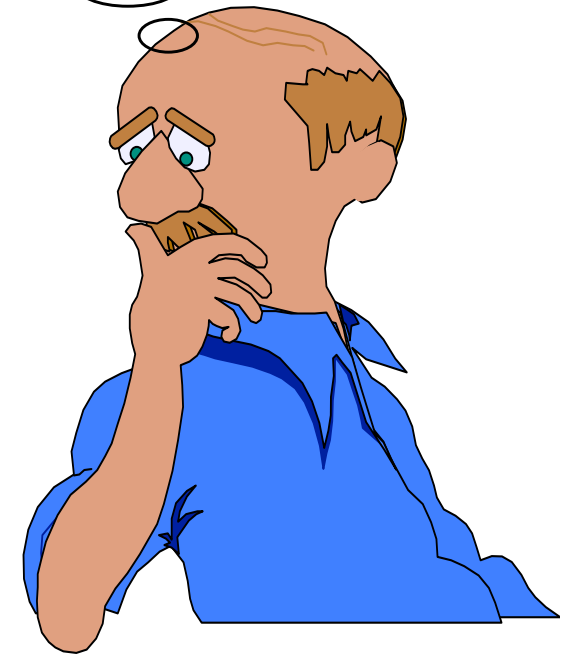

Variable Cycle Necessary (Variable Nozzle)

Chez Hall, Tom Hynes

Ultra-High Bypass Ratio Turbofan with Variable Nozzle

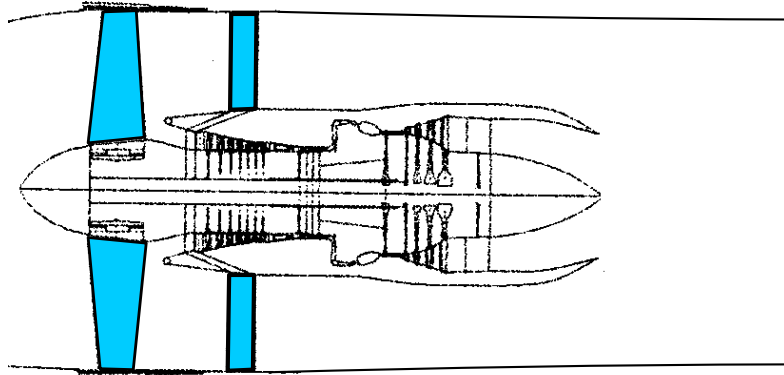

Nozzle open for take-off

- quiet low speed jet
- operating far from instability (surge)

Optimise the nozzle opening throughout climb for low noise

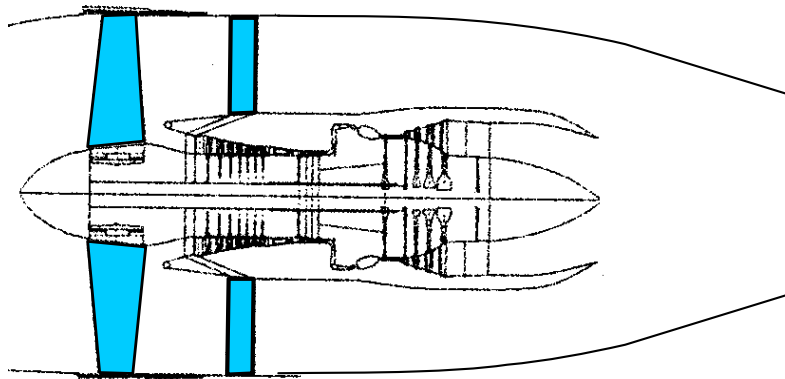

Nozzle closed for cruise as for conventional turbofan

- can achieve peak efficiency
- hence low specific fuel consumption

BUT

This would solve the jet noise and engine cruise efficiency problems

BUT

How could such engines be fitted onto an aircraft ?

What about the drag on the nacelles ?

How can we reduce the other engine noise sources ?

We want

- to shield much of the engine noise from listeners on the ground
- extensive, effective sound absorbing liners
- an airframe with a low approach velocity, no flaps nor slats
- a quiet engine

SAX 40 – Silent Aircraft Conceptual Design

**Mission: 215 passengers (3 class), cruise Mach 0.8,
5,000 nm range**

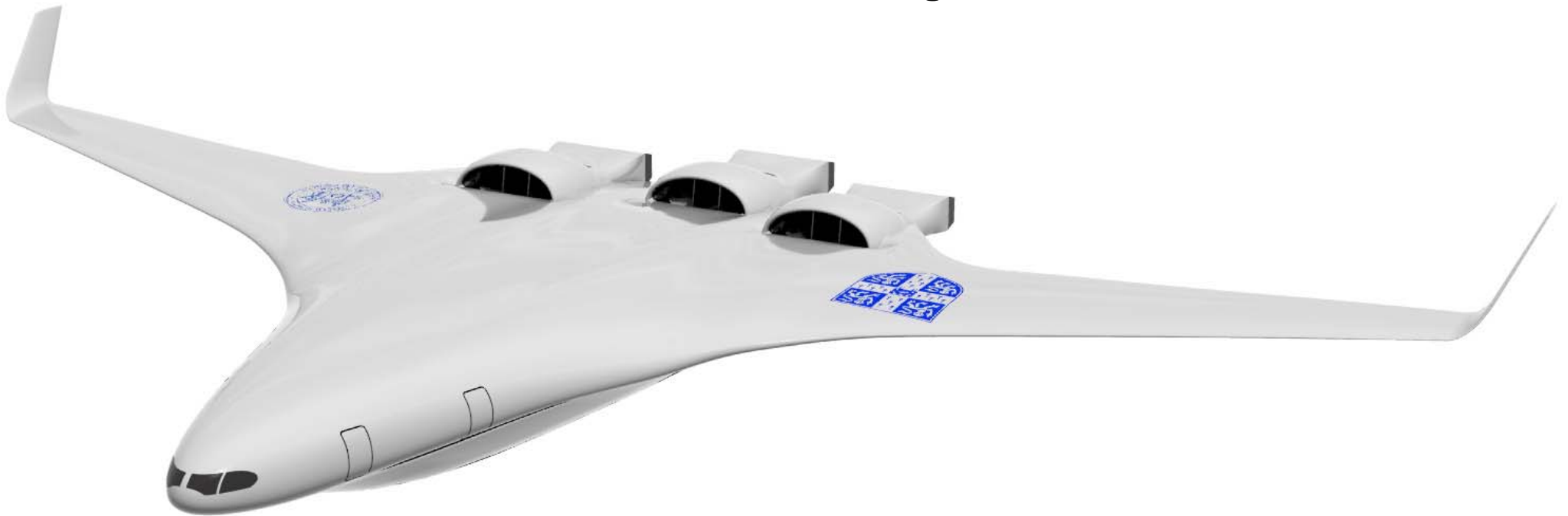

SAX 40 – Silent Aircraft Conceptual Design

**Mission: 215 passengers (3 class), cruise Mach 0.8,
5,000 nm range**

3 engines – each engine has a single core driving 3 fans

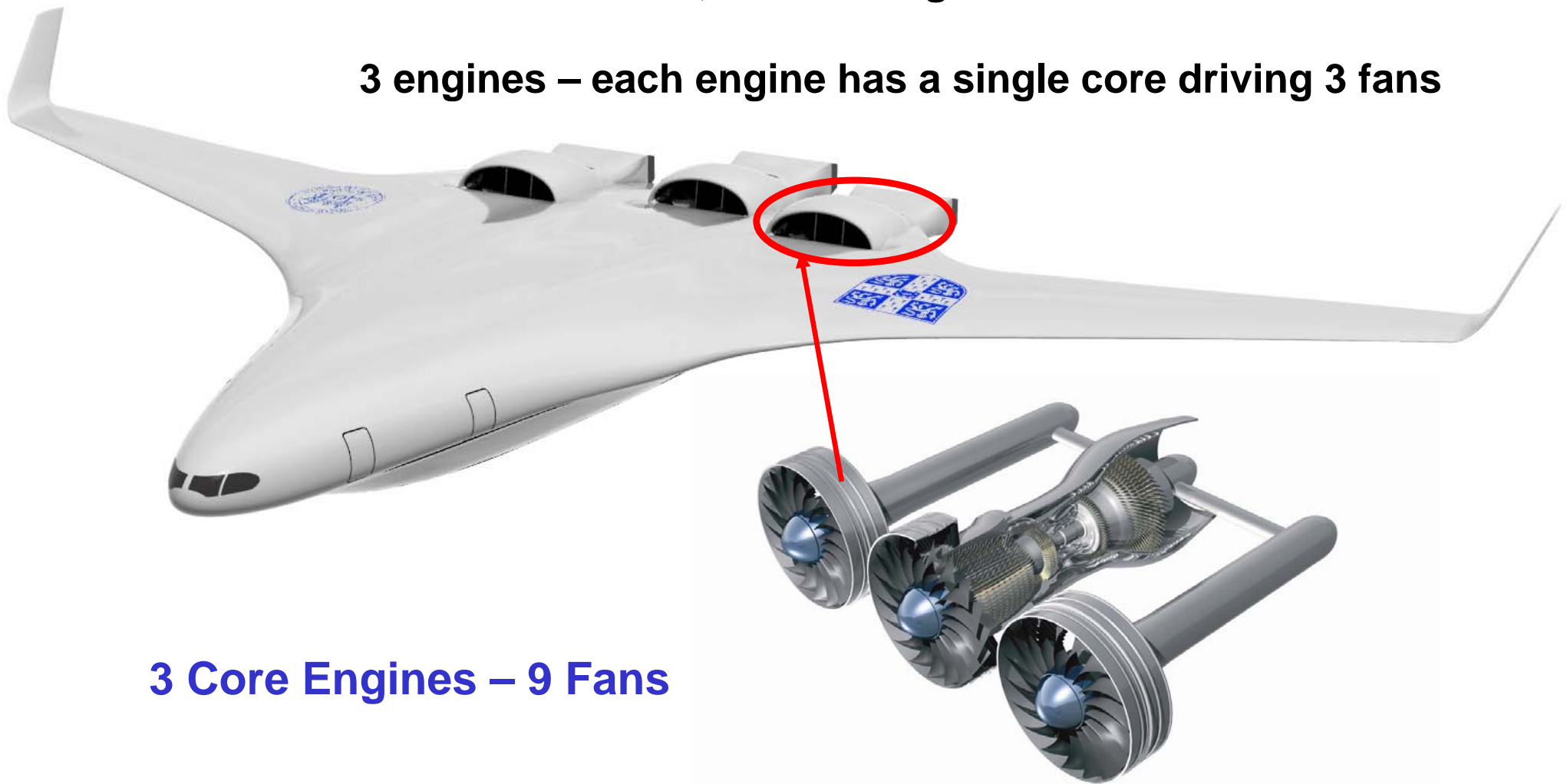

3 Core Engines – 9 Fans

SAX 40 – Silent Aircraft Conceptual Design

**Mission: 215 passengers (3 class), cruise Mach 0.8,
5,000 nm range**

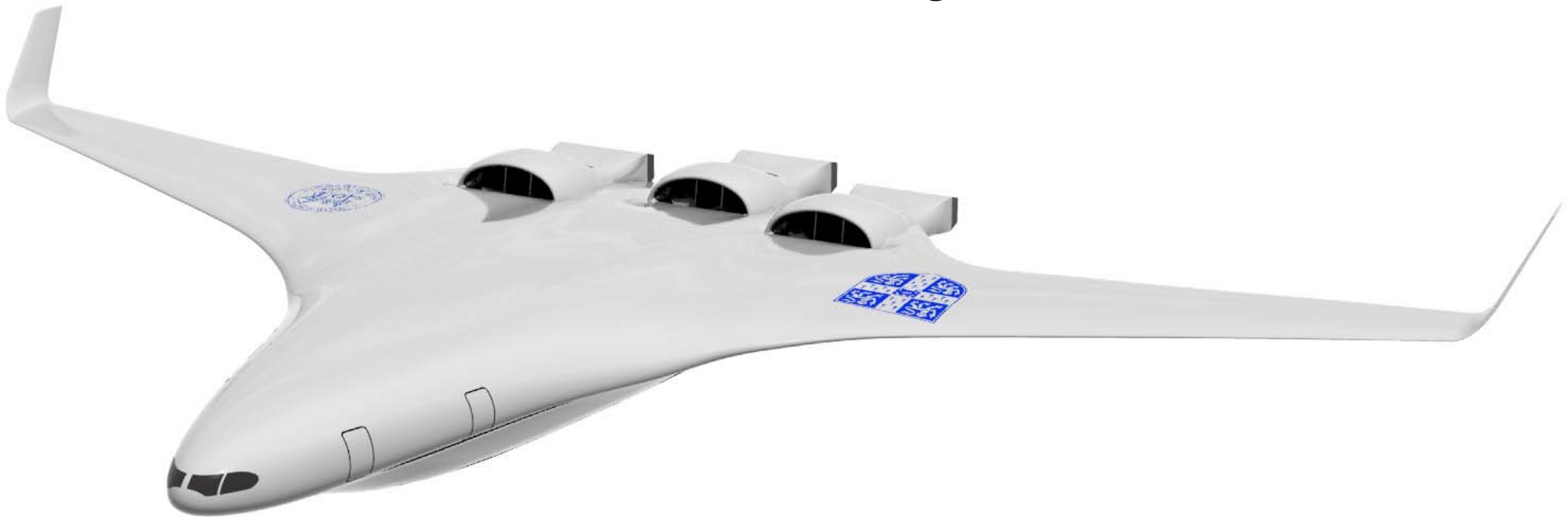

Fuel Burn potential of 124 pax-miles per US gallon (101 for B777)
SAX-40 cruise ML/D: 20.1 (Boeing PW BWB: 17-18 1; Boeing 777: 17.2)
Noise estimated at 62 dBA outside airport perimeter (background noise)

SAX 40 – Silent Aircraft Conceptual Design

**Mission: 215 passengers (3 class), cruise Mach 0.8,
5,000 nm range**

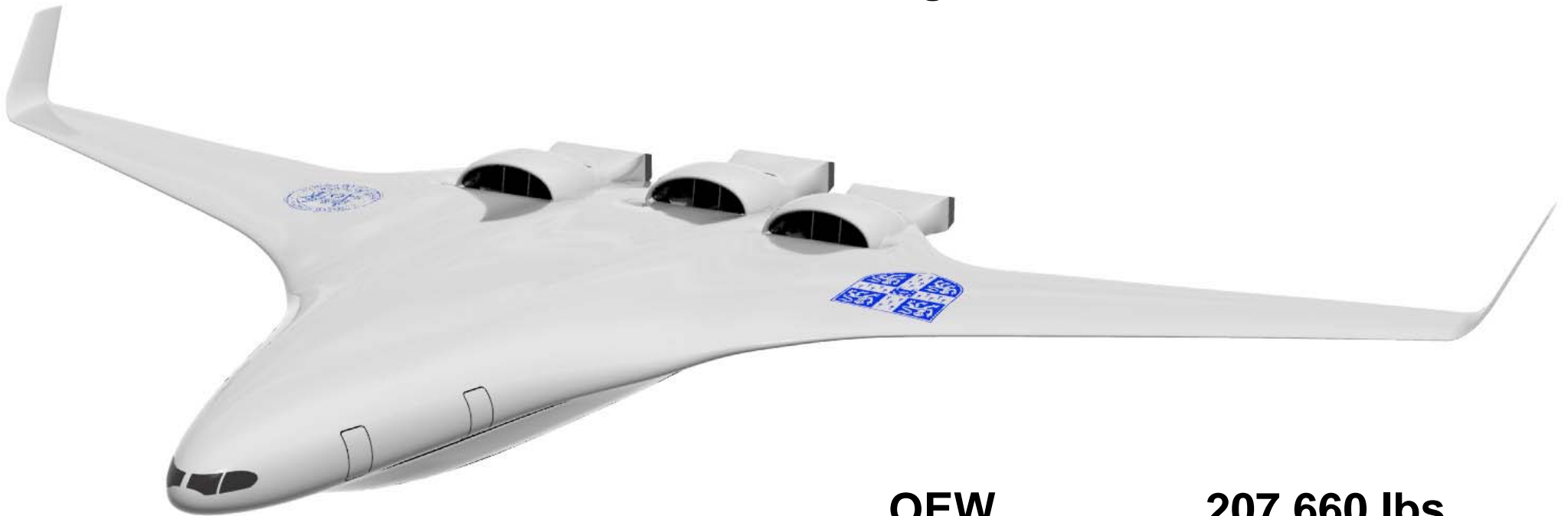

OEW	207,660 lbs
Payload	51,600 lbs
Fuel	73,310 lbs
MTOW	332,560 lbs

SAX-40 Four-View Rendering

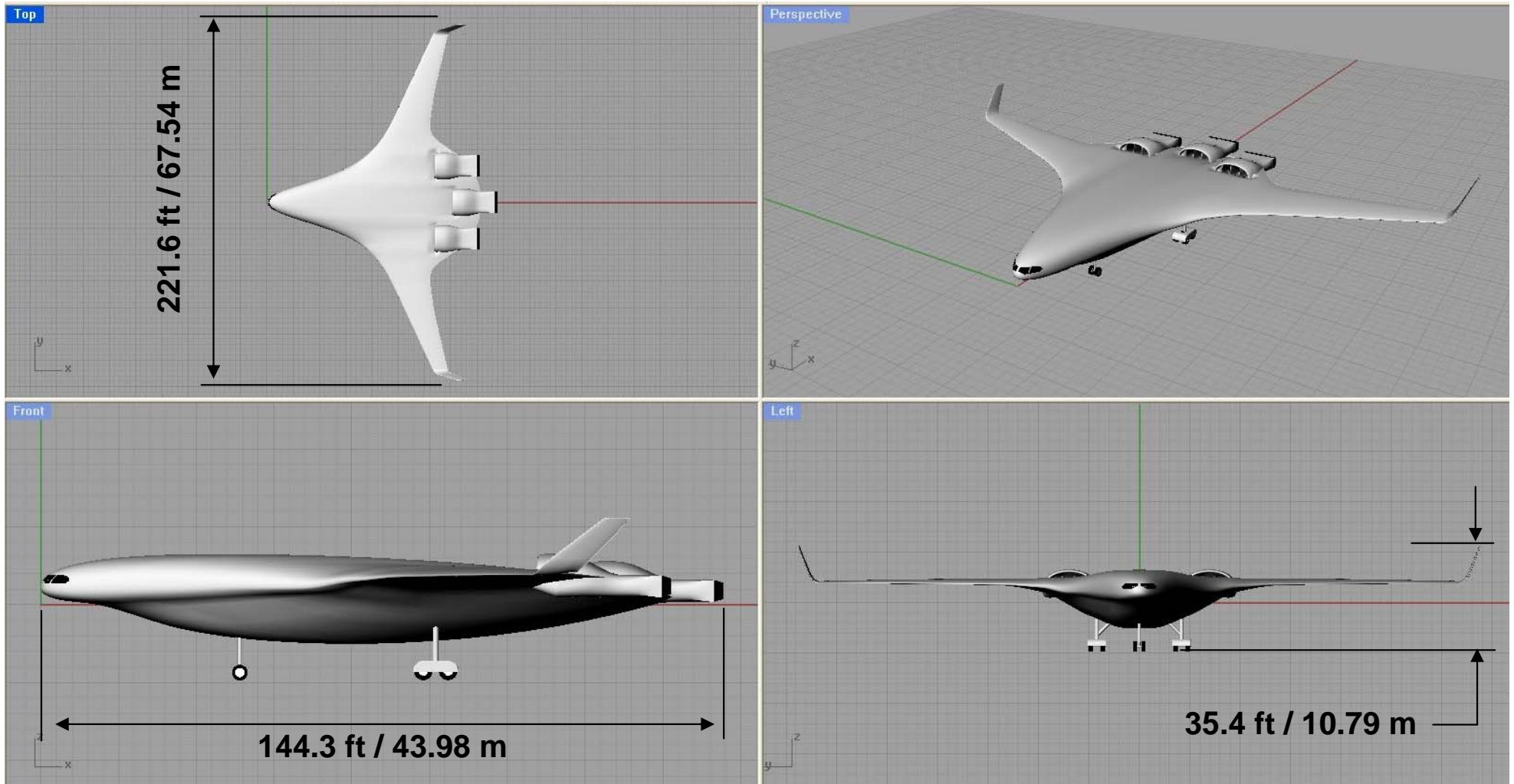

Pitch control for tail-less aircraft

- Issue: highly loaded outer wing yields nose down moment
→ current BWB concepts use reflex cambered centerbody profile, symmetric outer wing profiles, and relatively large control surfaces yielding performance penalty.

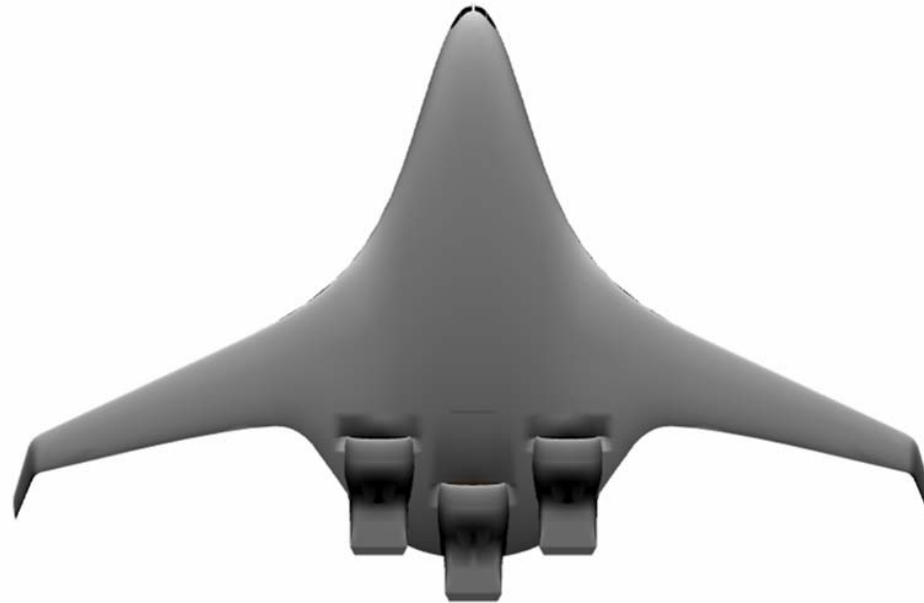

Aircraft Aerodynamic Features - Cruise

- We use **leading edge carving** under the centre-body, moves lift on centre-body forward, outer wings can then be optimised and achieve elliptical lift distribution

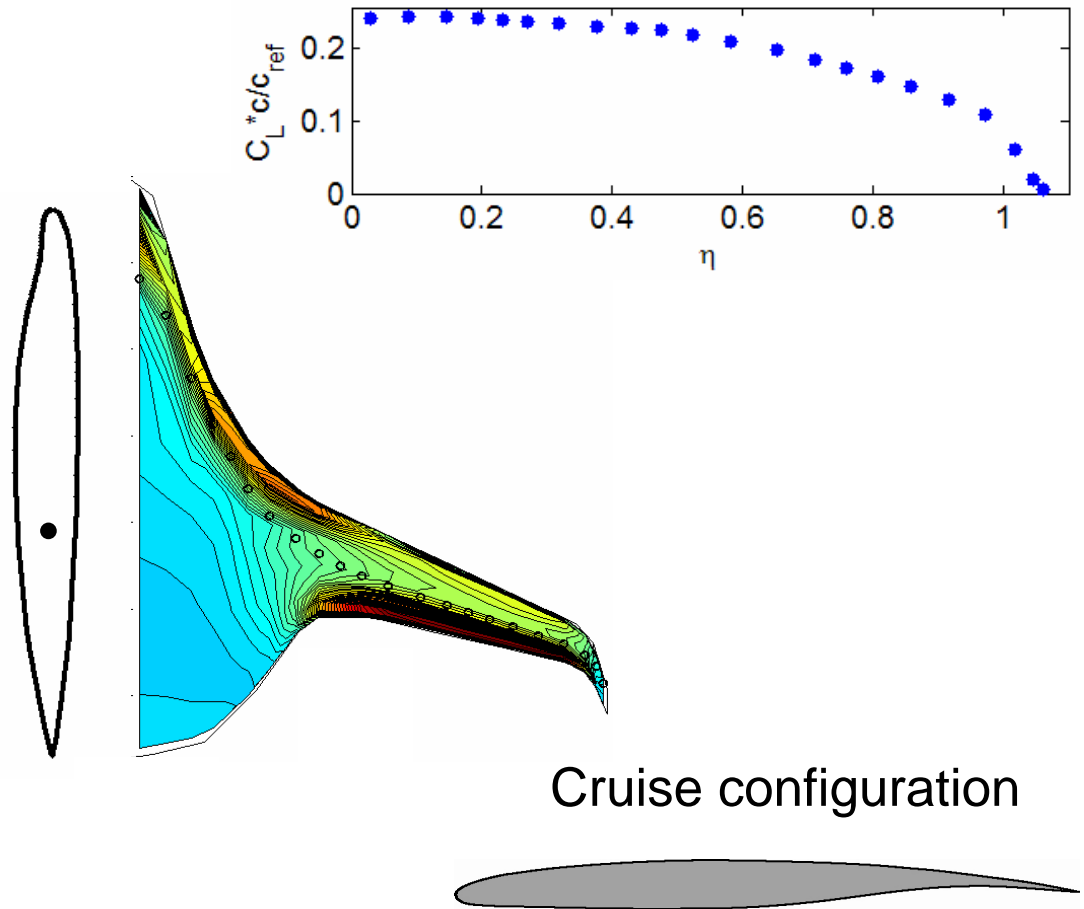

Aircraft Aerodynamic Features - Cruise

- We use leading edge carving under the centre-body, moves lift on centre-body forward, outer wings can then be optimised and achieve elliptical lift distribution
- Centrebody design is a 3D problem
- Designed using Q3D methodology

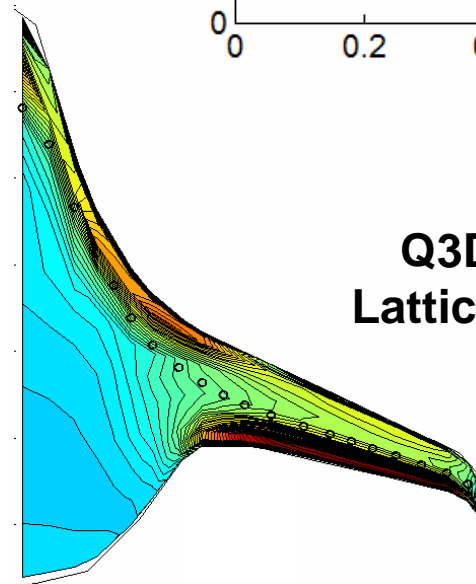
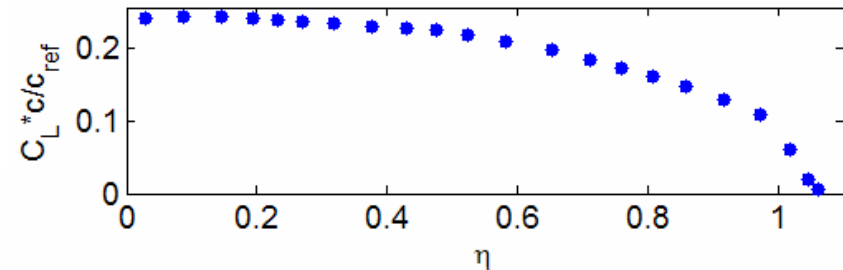

Q3D Vortex
Lattice Solution

Cruise configuration



Aircraft Aerodynamic Features - Cruise

- We use leading edge carving under the centre-body, moves lift on centre-body forward, outer wings can then be optimised and achieve elliptical lift distribution
- Centrebody design is a 3D problem
- Need validation of Q3D methodology
- Viscous 3D CFD computation by Boeing Phantom Works

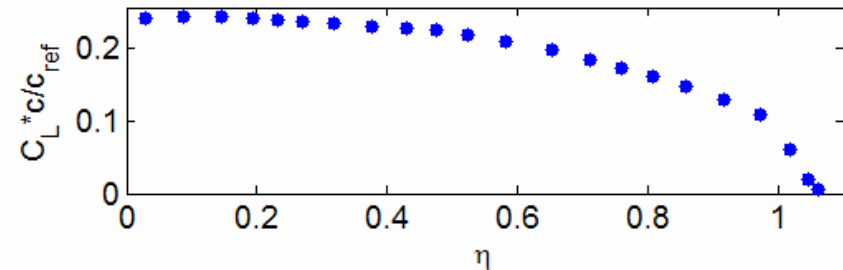

CFL3DV6
Solution

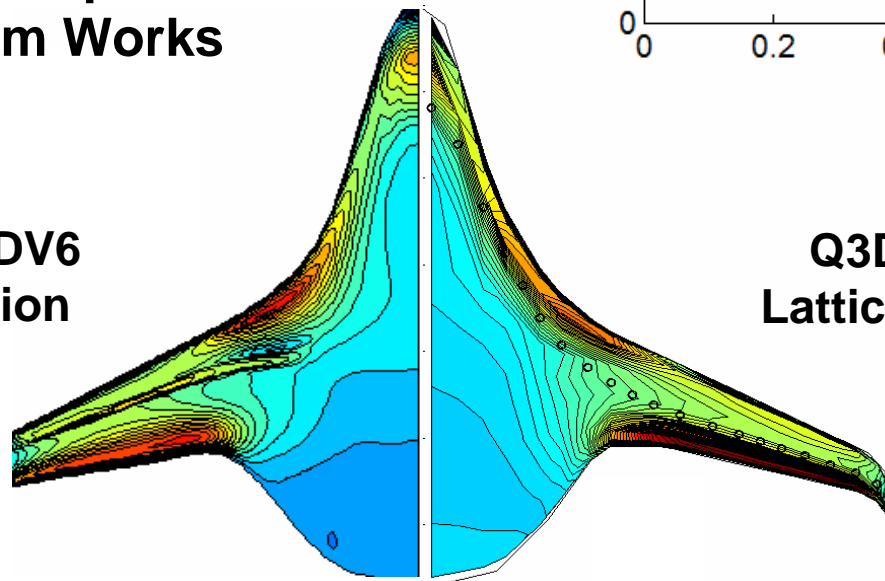

Q3D Vortex
Lattice Solution

Cruise configuration



Airframe Design for Low Noise

Goal: *low approach speed with competitive cruise performance*

Jim Hileman, Zolti Spakovszky

Airframe noise proportional to u^n / r^2
where $n = 5$ for scattering sources
and $n = 6$ for dipole sources.

Flaps and slats need to be eliminated
from design. Fair undercarriage.

Low speed flight on approach, i.e.
stall speed, is directly related to
cruise performance

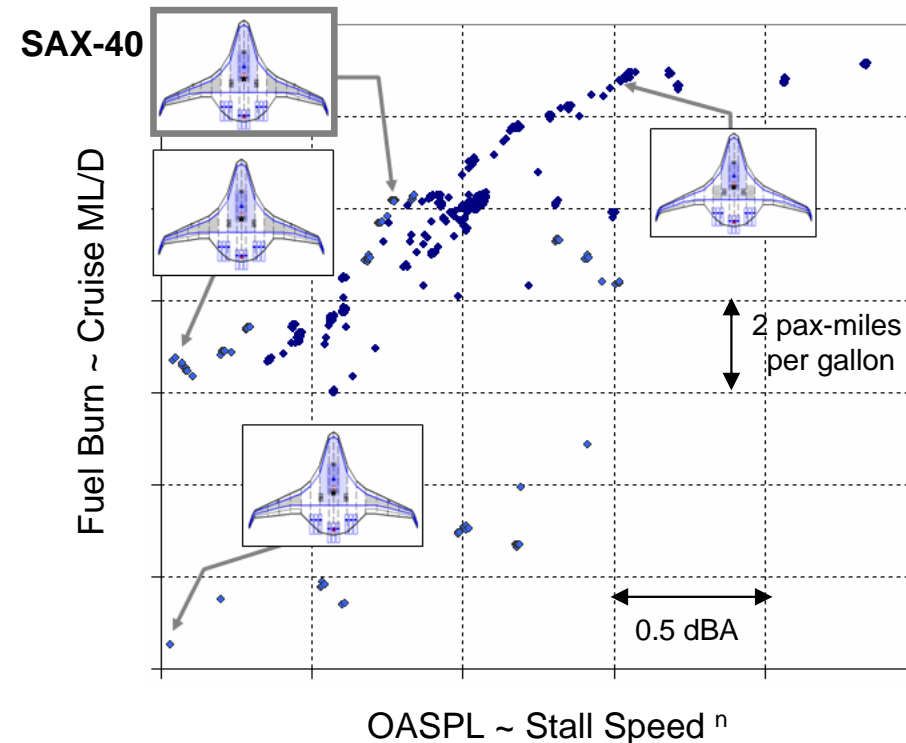

Need to minimise penalty in cruise Lift/Drag for low approach speed
through advanced centerbody design and outer wing optimisation

Aircraft Aerodynamic Features - Approach

- Balance pitching moment with deployable drooped leading edge and unload trailing edge on approach → high lift coefficient and high induced drag enables a quiet, low speed approach

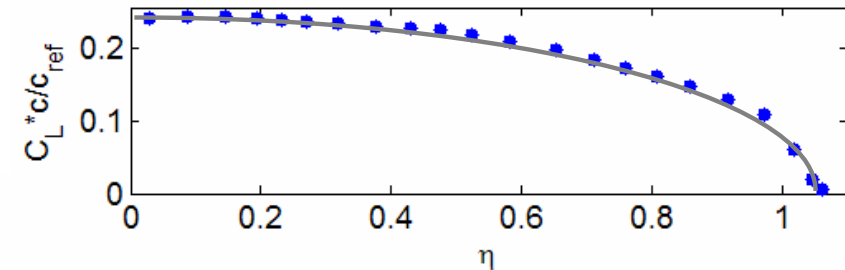
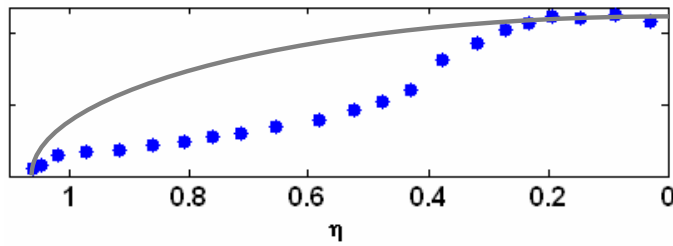

**Elevon Deflection +
Vectored Thrust
maximise induced
drag**

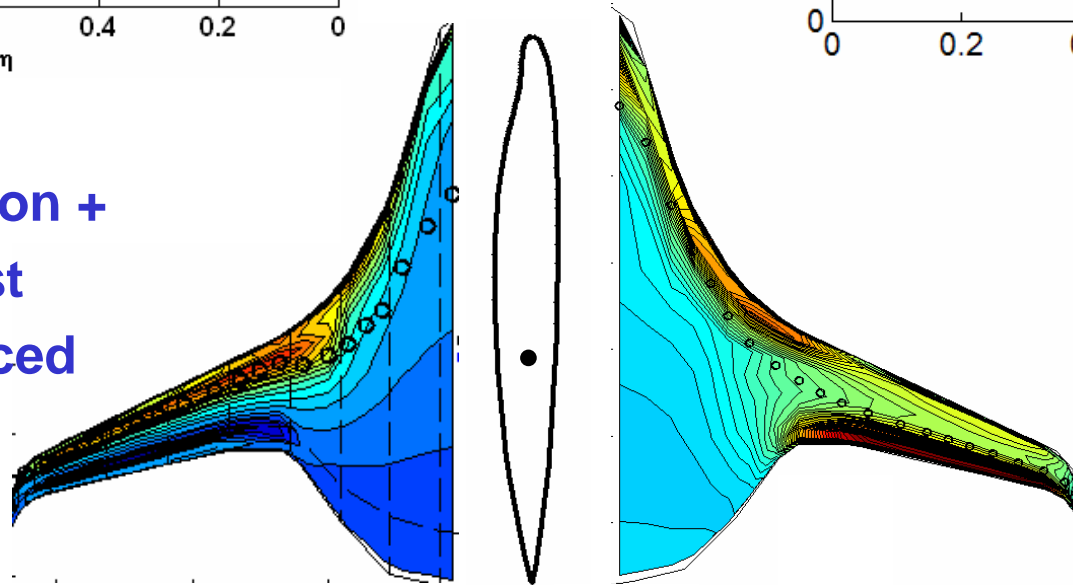

Approach configuration

Cruise configuration



Engine Options

Tom Hynes, Chez Hall, Elena de Rosa Blanco

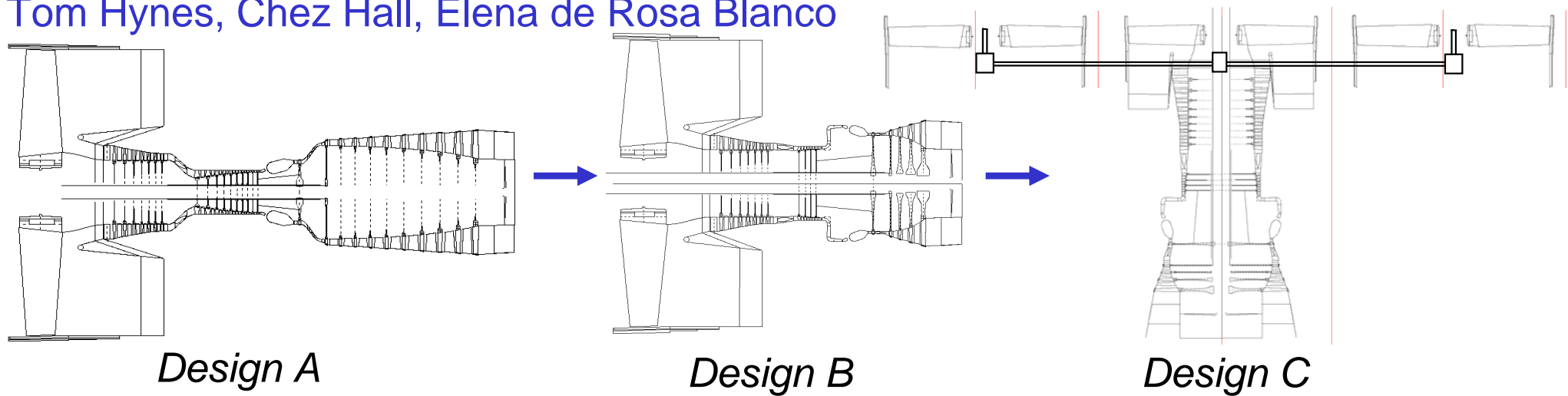

	<i>Design A</i>	<i>Design B</i>	<i>Design C</i>
Configuration	3-spool turbofan	2-spool, geared	multiple fan
<i>Number of fans</i>	4	4	9
<i>Fan diameter, D_f (m)</i>	2.16	2.16	1.29
<i>IP+LP turbine stages</i>	10	4	4
Engine weight (%)	100	99.2	81.3

Main Design Features of Granta-3401

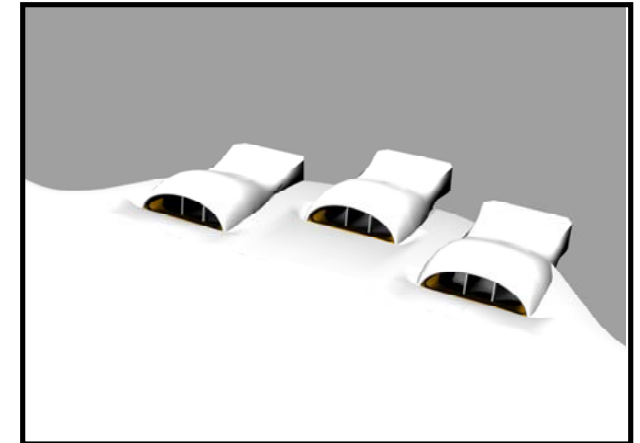
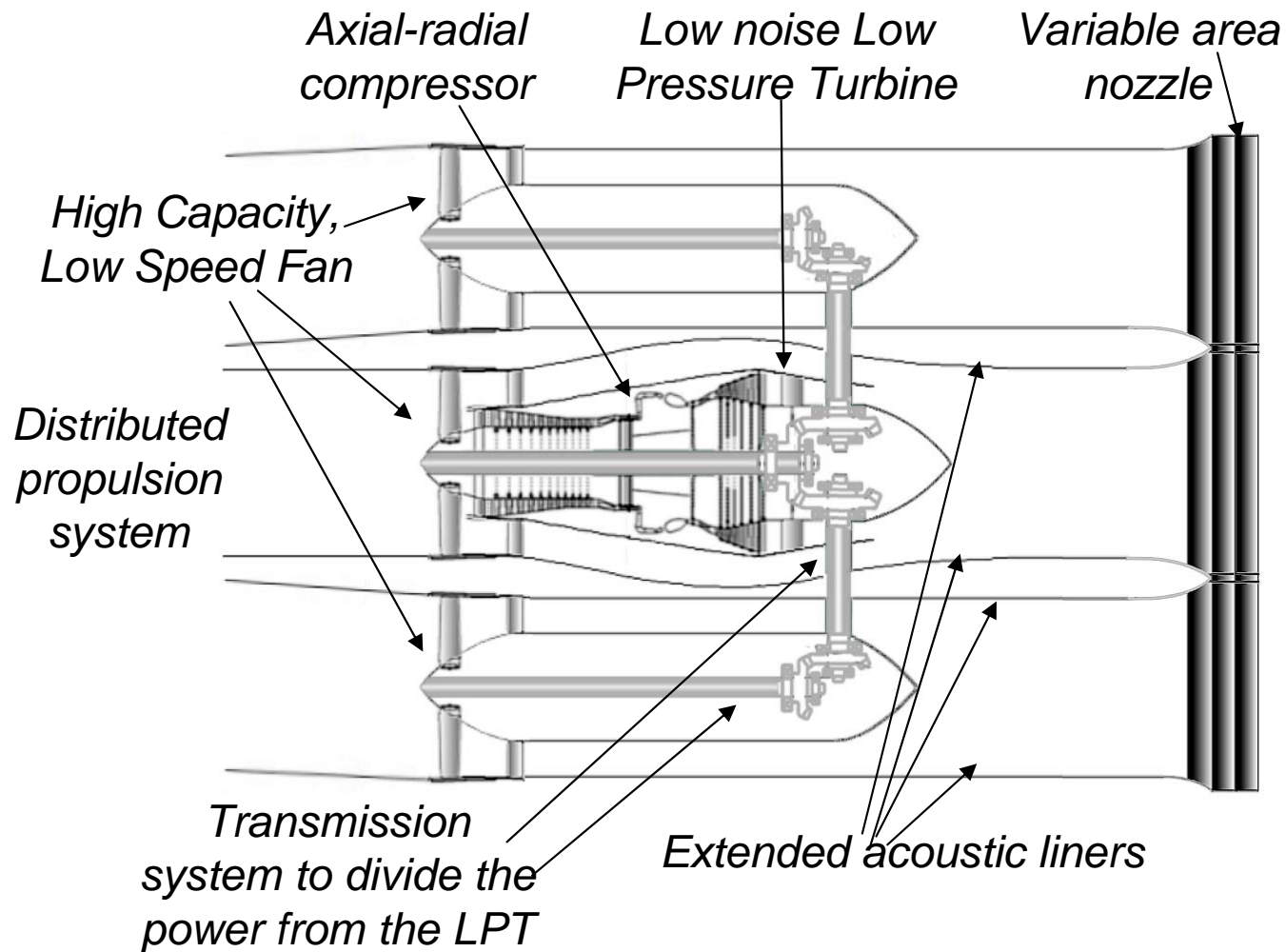

Number of engines	3
Number of fans	9
Fan diameter	1.20 m
Bare engine length	2.46 m
Max. Thrust per engine	150 kN

No gearbox – fan and turbine same speed

Main Design Features of Granta-3401

Fan

- **Designed for use with variable area nozzle**
 - **Use forward sweep to increase part speed capacity for high mass flow, lower velocity jet at take-off**
 - **Requires that outlet Guide Vanes can support high incidence range**
- **Reduced fan source noise**
 - **fan rotor tones are eliminated by having a subsonic fan tip wherever possible (flyover and approach)**
 - **when supersonic flow is unavoidable the fan is operated with the primary shock structure ingested to minimise forward propagating noise**
 - **rotor-stator interaction tones are cut-off in both fan and compressor**
 - **Maximise rotor-stator gap**

Turbine

- **Eliminate tonal noise by using high LPT rotational speed (no gearing) and the careful selection of number of rotor blades**

Benefits of a distributed propulsion system

- **Weight saving**
- **Distributed propulsion arrangement allows for small fan diameter (D).**
- **L/D determines liner efficacy (need $L/D = 2$)**
 smaller D \Rightarrow smaller L
- **Smaller L**
 \Rightarrow smaller undercarriage
- **Smaller L \Rightarrow inlet further back giving reduced inlet Mach number**

Granta-3401 (3 Engine Clusters)

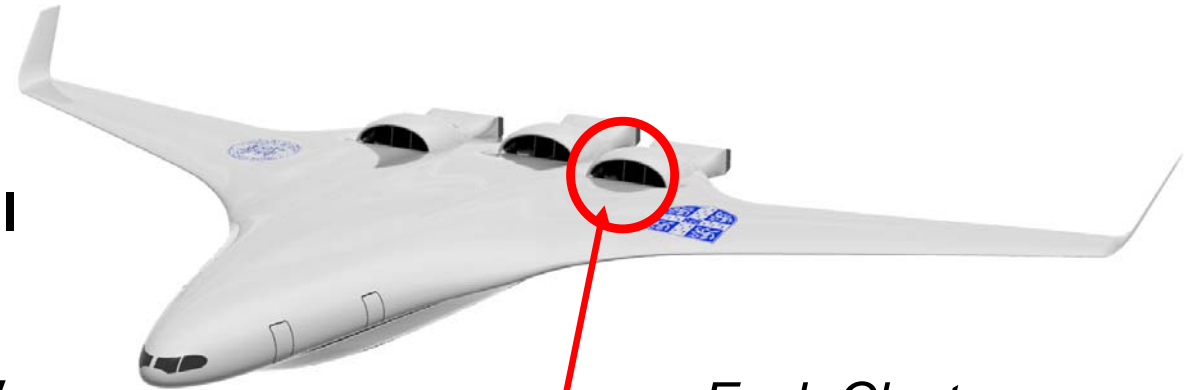

Each Cluster

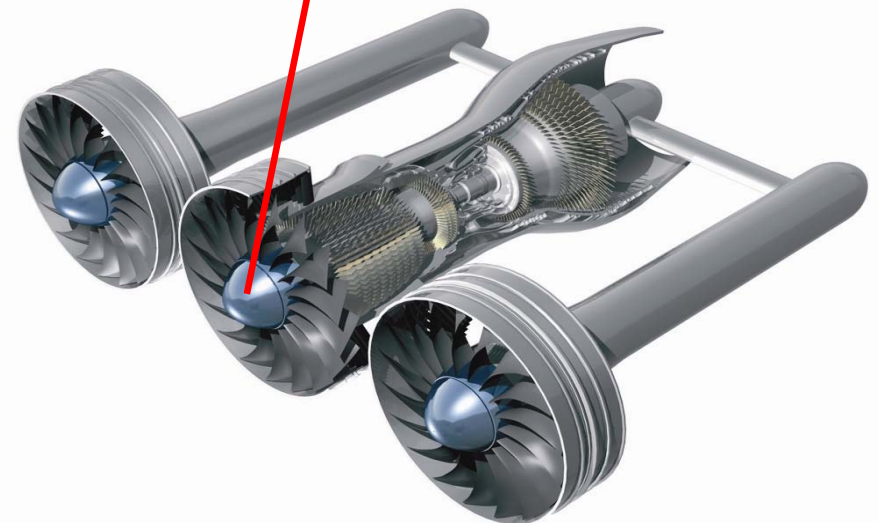

Boundary Layer Ingestion
Detailed Transmission Design

Benefits of a distributed propulsion system

- **Smaller D means faster spool-up**
 - very low approach thrust
 - reduces drag requirement
- **Easier to embed – reduced nacelle wetted area with easier inlet duct**
- **Distributed propulsion system enhances ability to ingest airframe boundary layer, with propulsion efficiency benefit.**

BUT

- **Design of airframe centre-body and engine intakes need to be integrated**
- **Harder to position engines for disk burst requirements**

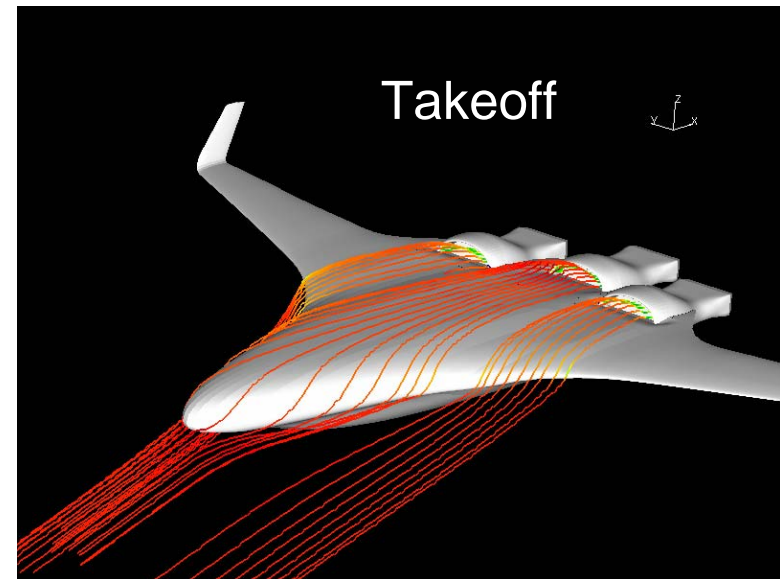
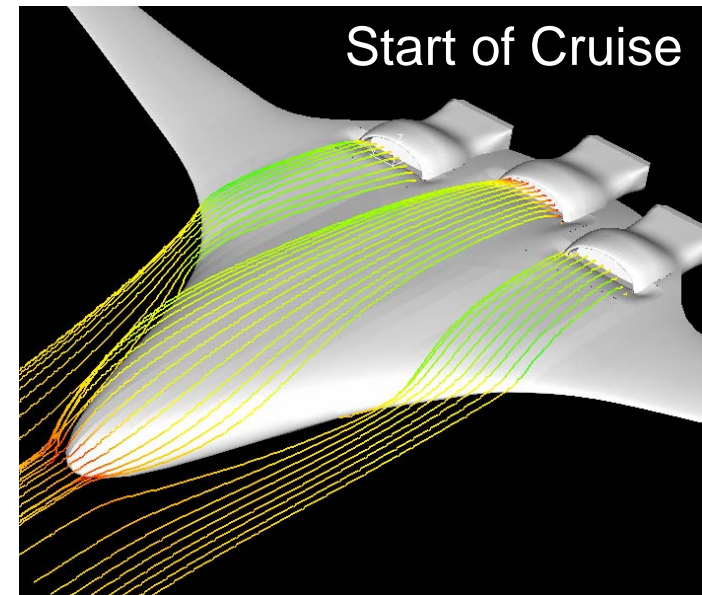

Longitudinal Stability and Control

Steve Thomas, Ann Dowling

- **Linearised state-space model of SAX40**
- **Controller designed to damp phugoid oscillation**
 - inputs engine power, elevon angle and direction of vectored thrust
- **Nonlinear model**
 - used to investigate 'go-around' manoeuvre

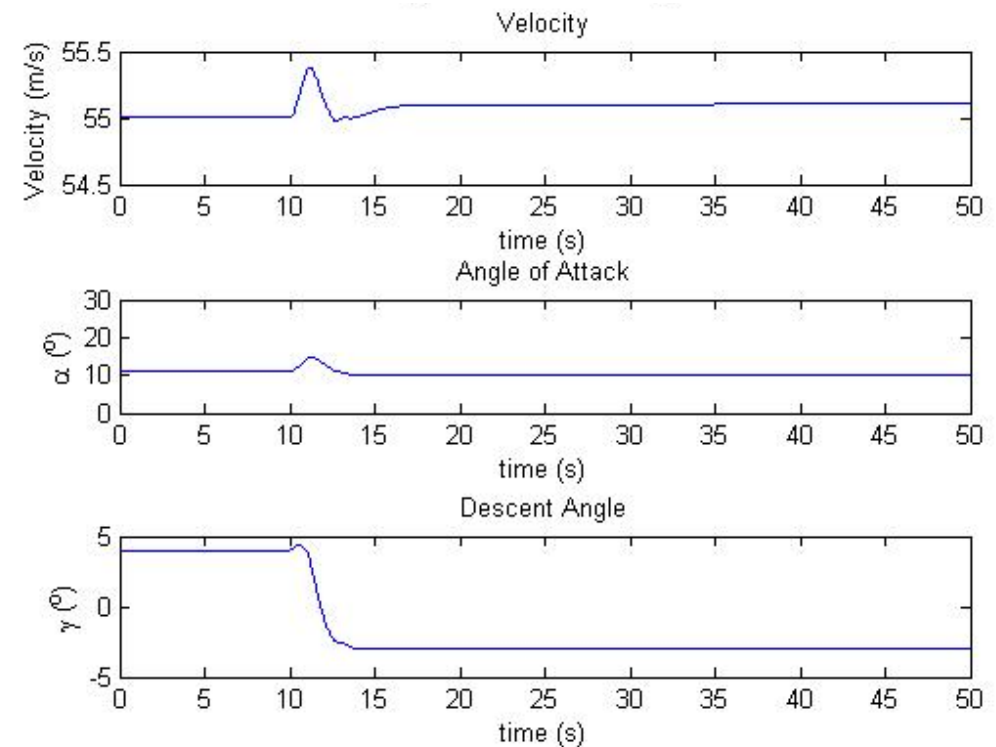
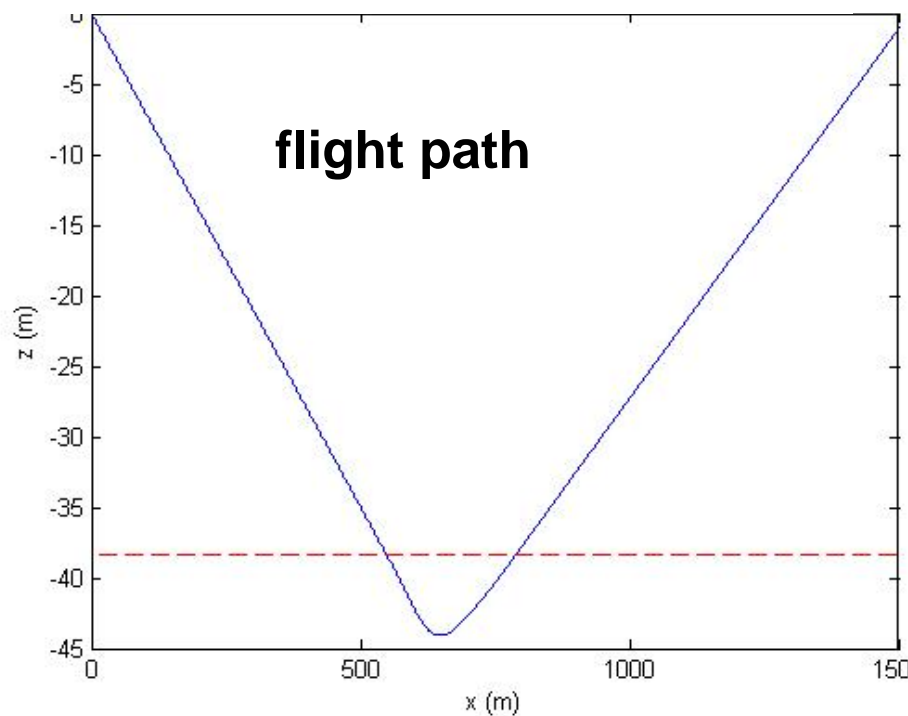

Longitudinal Stability and Control

Steve Thomas, Ann Dowling

- **Linearised state-space model of SAX40**
- **Controller designed to damp phugoid oscillation**
 - inputs engine power, elevon angle and direction of vectored thrust
- **Nonlinear model**
 - used to investigate 'go-around' manoeuvre
 - **go-around can be completed in well under 15 m**
 - response to gusts
 - **can recover from upto 10ms^{-1} gust,**
 - **in more gusty conditions would use faster, noisier approach velocity than 60ms^{-1}**

Technologies for Low Noise

- **The engines have been designed to be very efficient and quiet
..... but they are not quiet enough**
- **Shielding and sound absorbent liners are important contributors
towards achieving the our noise target**

Shielding

- In the Silent Aircraft the engines are placed above the airframe to prevent noise from reaching the observer

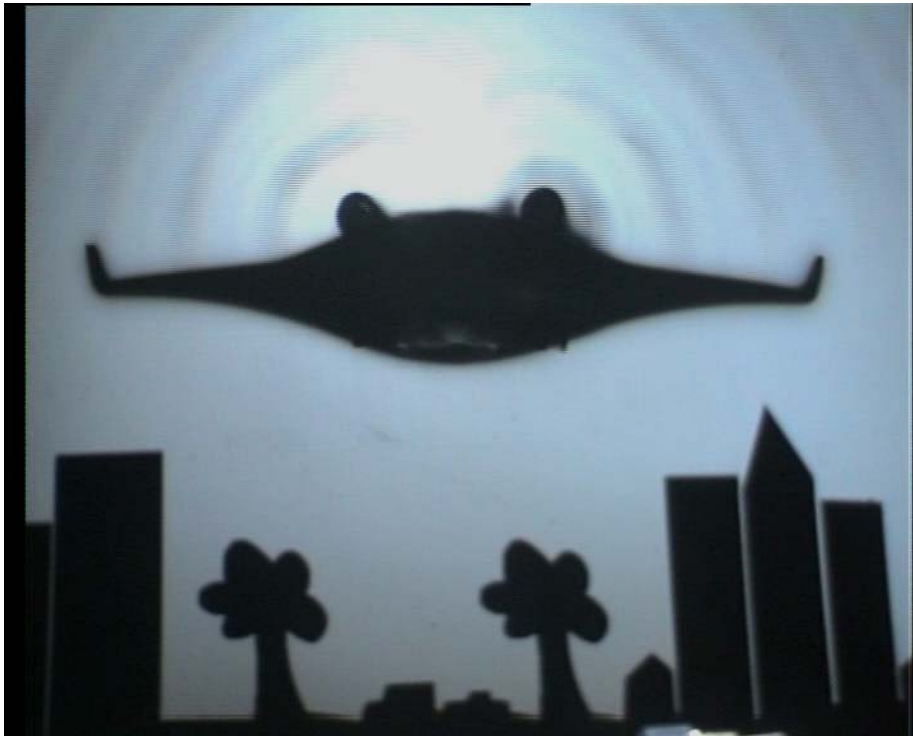
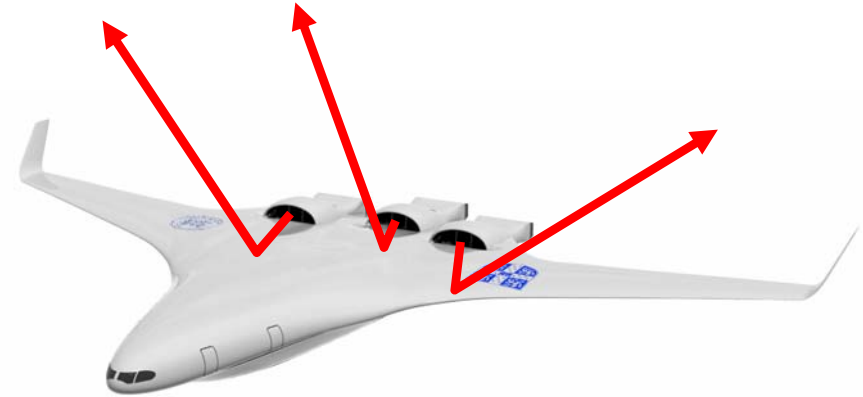

Shielding

- In the Silent Aircraft the engines are placed above the airframe to prevent noise from reaching the observer

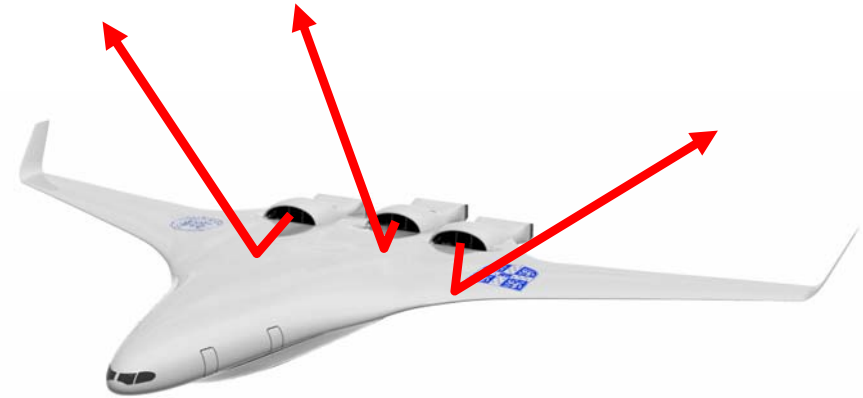

Shielding

- In the Silent Aircraft the engines are placed above the airframe to prevent noise from reaching the observer
- Quantifying the effects of shielding
- Predicted via BEM (low frequencies), ray theory (mid and high frequencies), including effect of direct, reflected, creeping and edge scattered rays

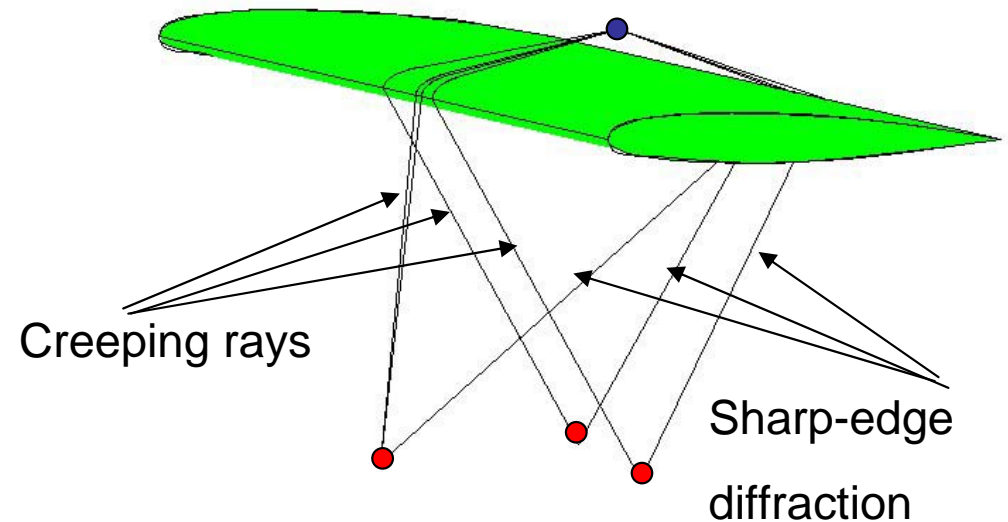
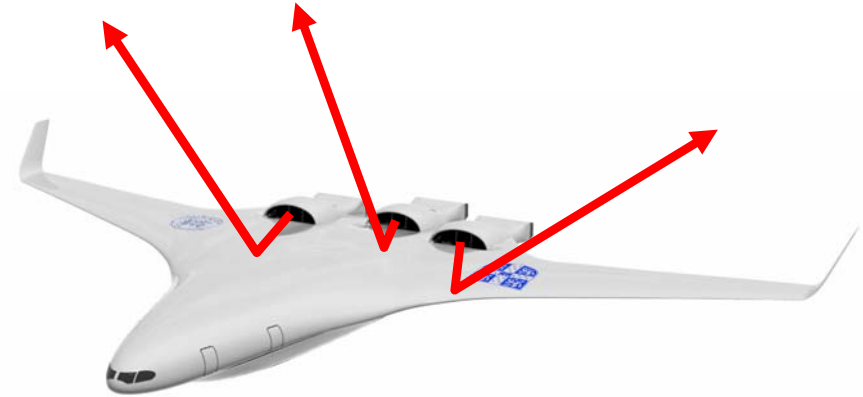

Shielding

- In the Silent Aircraft the engines are placed above the airframe to prevent noise from reaching the observer
- Engine forward noise sources are virtually eradicated on the ground
- Effects of shielding predicted via BEM (low frequencies), ray theory (mid and high frequencies), including effect of direct, reflected, creeping and edge scattered rays

For maximum benefit

- Engines located above the wing
- Source close to wing

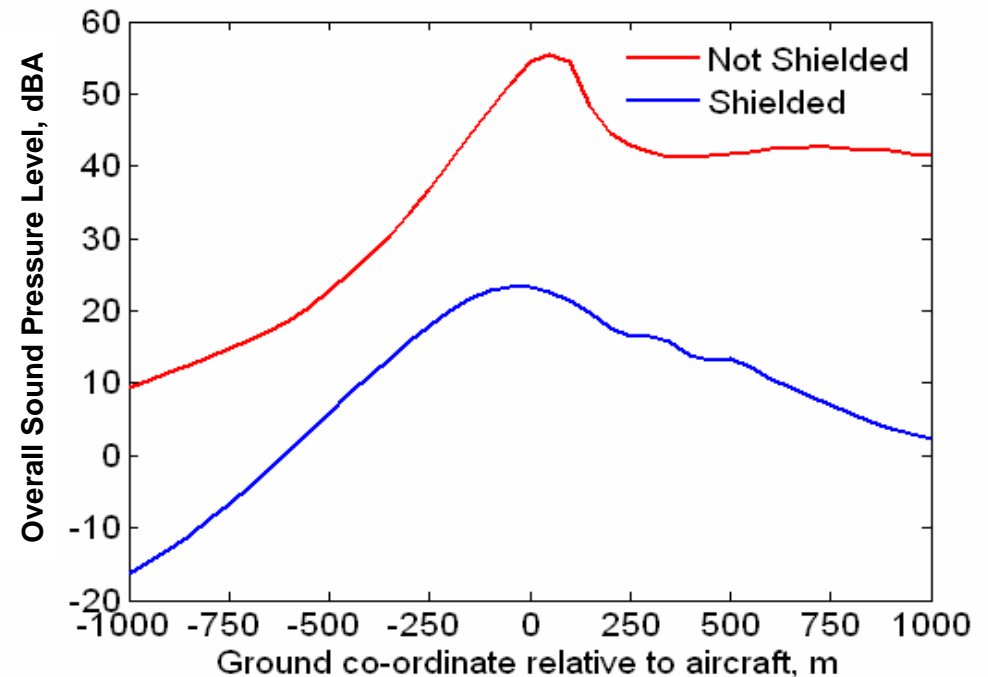
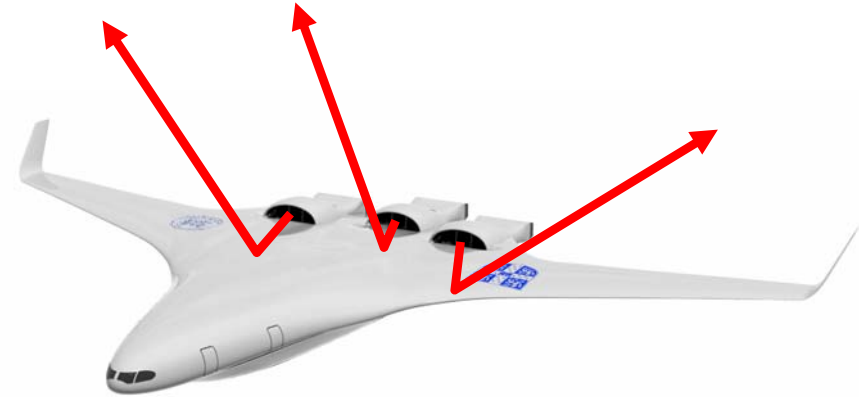

Impact of shielding on fan forward noise

Acoustic liners

The Silent Aircraft uses extensive, multi-segment liner, optimised to attenuate fan broadband noise

Tom Law, Ann Dowling

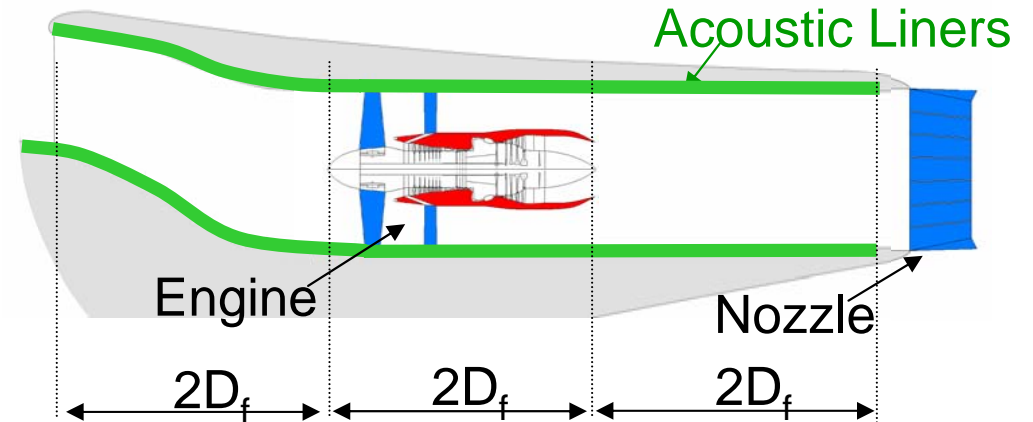

Requirements

- $L=2D_f$ mixer duct
- Helped by small diameter fan
- Properties of each segment (porosity, liner depth, hole size), length and order of liner segments are optimised

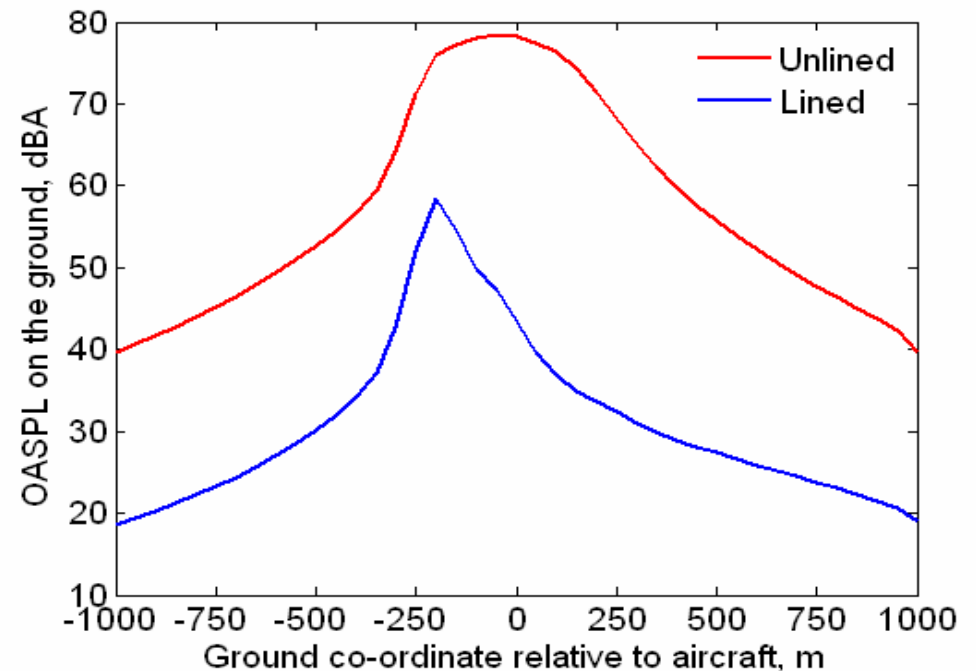

Impact of optimised liners on fan rearward noise

Conventional Engine vs. Granta-3401

Auralisation Ho-Chul Shin

- for **FLY-OVER condition, 40° behind** (3-sec each)

- 1) Modern conventional engine
- 2) GRANTA 3401 bare engine
- 3) GRANTA 3401 (shielding)
- 4) GRANTA 3401 (liners)
- 5) GRANTA 3401 (shielding , liners)

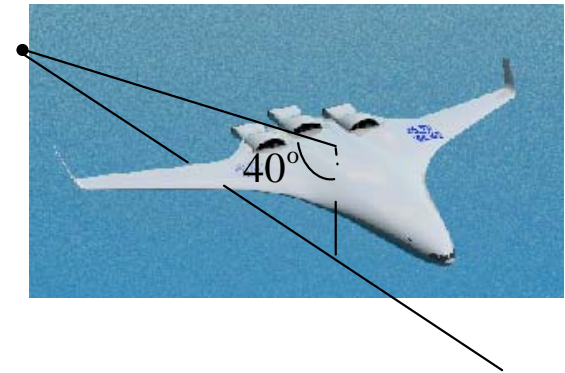

- for **FLY-OVER condition, 40° ahead** (3-sec each)

- 1) Modern conventional engine
- 2) GRANTA 3401 bare engine
- 3) GRANTA 3401 (shielding)
- 4) GRANTA 3401 (liners)
- 5) GRANTA 3401 (shielding , liners)

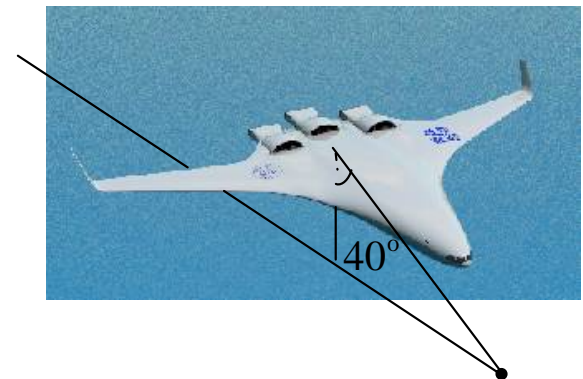

Enabling Technologies for Low Airframe Noise

- **Low airframe noise on approach is due to**
 - lower approach speed 60ms^{-1}
 - an efficient airframe with lower stall speed
 - low-noise drag, combination of induced drag and vectored thrust
 - engine with low flight-idle speed and quick spool up time
 - aircraft flying higher outside airport perimeter,
 - glide slope 3.9°
 - threshold displaced 1.2 km because lower landing speed enables shorter braking distance
 - a design with no flaps or slats
 - vectored thrust for trim to minimise control surface deflection
 - a deployable drooped leading edge on the wings to enable low-speed flight without more noise
 - low-noise fairings on the undercarriage
 - advanced airfoil trailing edge treatment

Enabling Technologies for Low Airframe Noise

- **Low airframe noise on approach is due to**
 - lower approach speed 60ms^{-1}
 - an efficient airframe with lower stall speed
 - low-noise drag, combination of induced drag and vectored thrust
 - engine with low flight-idle speed and quick spool up time
 - aircraft flying higher outside airport perimeter,
 - glide slope 3.9°
 - threshold displaced 1.2 km because lower landing speed enables shorter braking distance
 - a design with no flaps or slats
 - vectored thrust for trim to minimise control surface deflection
 - a deployable drooped leading edge on the wings to enable low-speed flight without more noise
 - **low-noise fairings on the undercarriage**
 - advanced airfoil trailing edge treatment

Low noise landing gear



Configurations are tested in the Department of Engineering wind tunnel

Noise performance is evaluated with an acoustic array

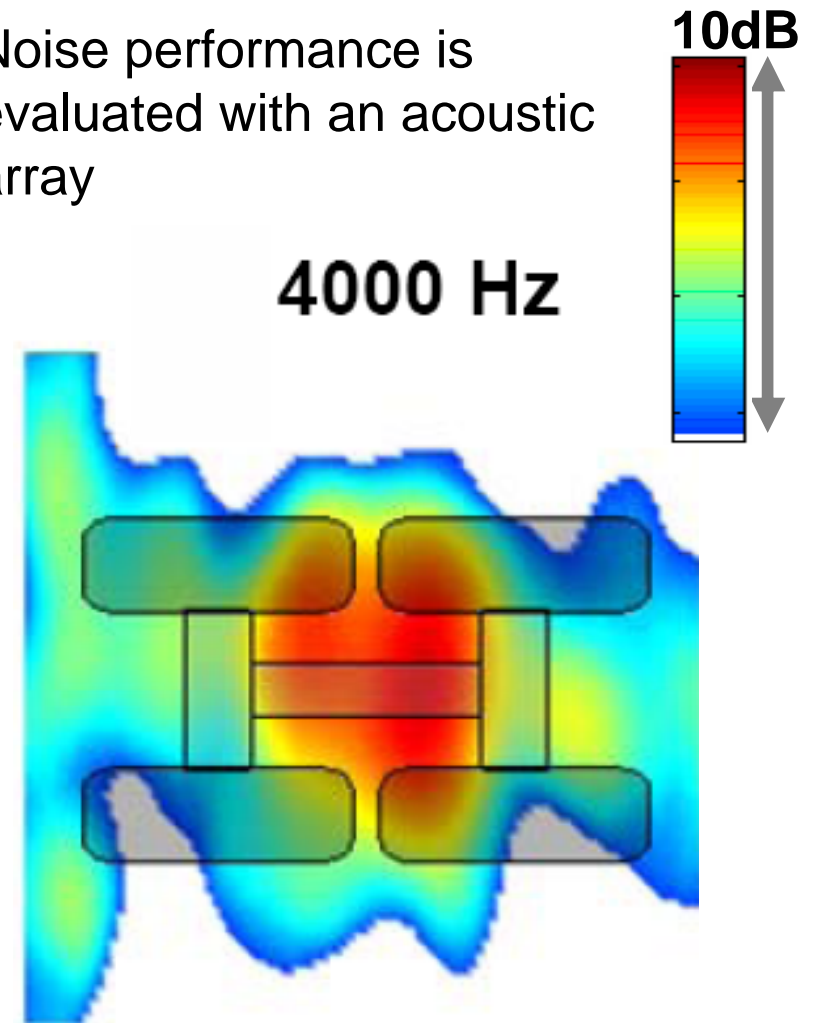

Low noise landing gear

Alex Quayle, Ann Dowling, Holger Babinsky

- **Enclose surface details**
 - 7 dBA at high frequencies
- **Two large wheels quietest but loading too high for SAX40**
- **Wheel edge shape**
 - upstream wheel sharp
 - rear wheel edge rounded
- **Fairings around front axle/strut**
- **Wheels staggered**

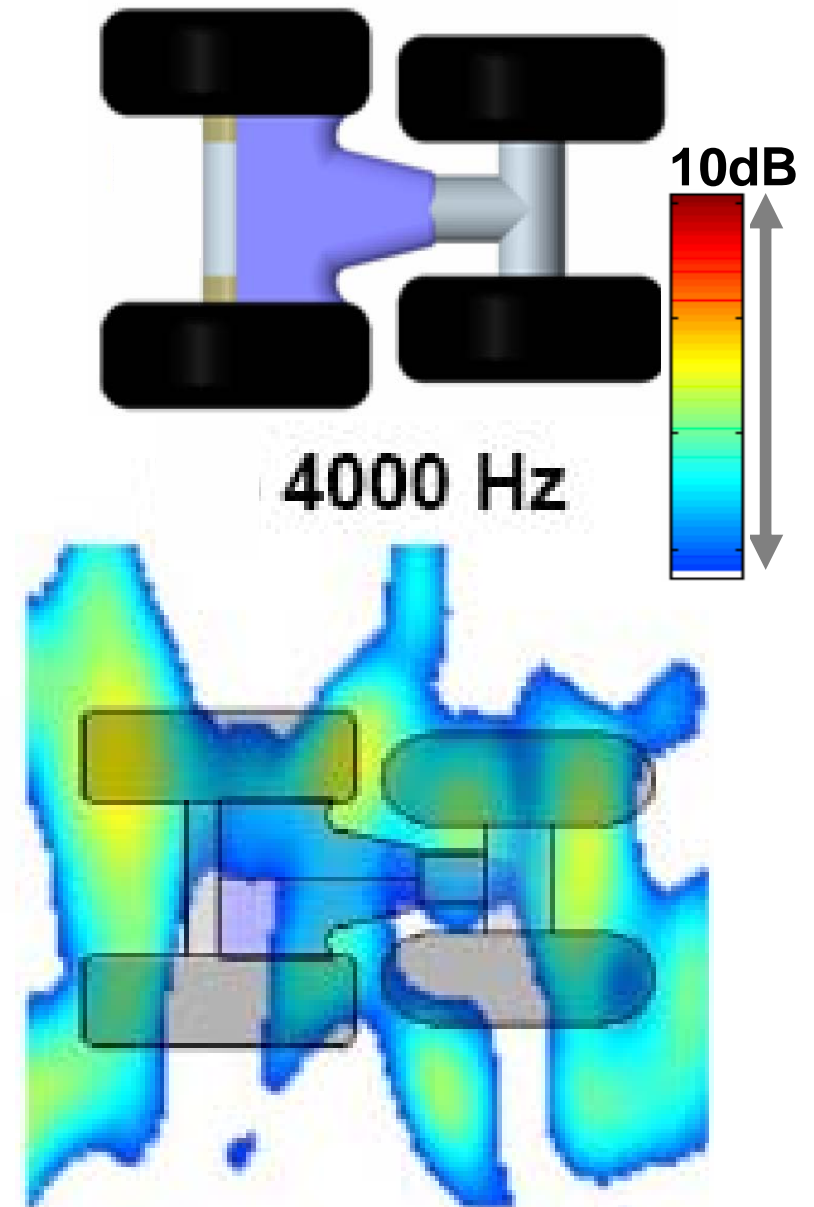

Low noise landing gear

Alex Quayle, Ann Dowling, Holger Babinsky

- **Enclose surface details**
-7 dBA at high frequencies
- **Two large wheels quietest but loading too high for SAX40**
- **Wheel edge shape**
 - upstream wheel sharp
 - rear wheel edge rounded
- **Fairings around front axle/strut**
- **Wheels staggered**

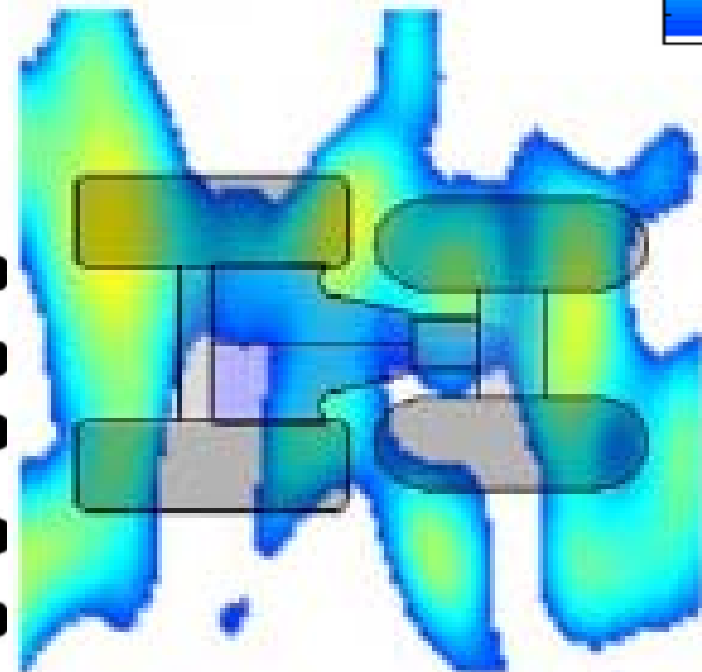
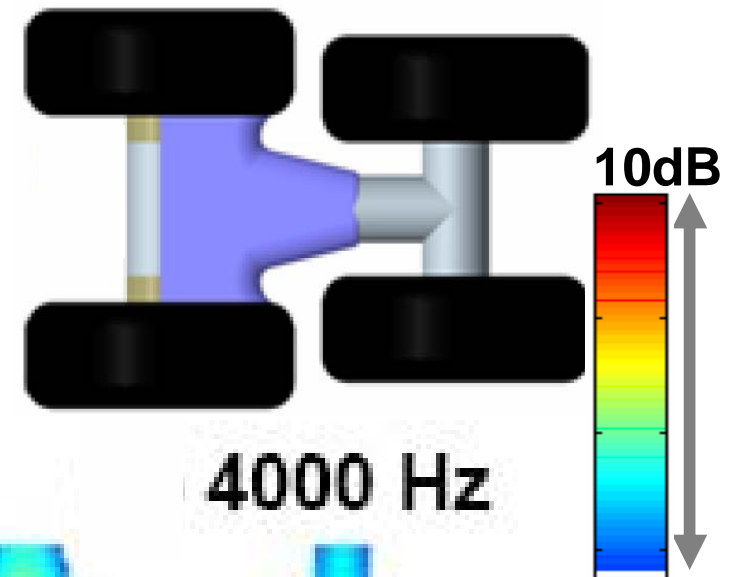
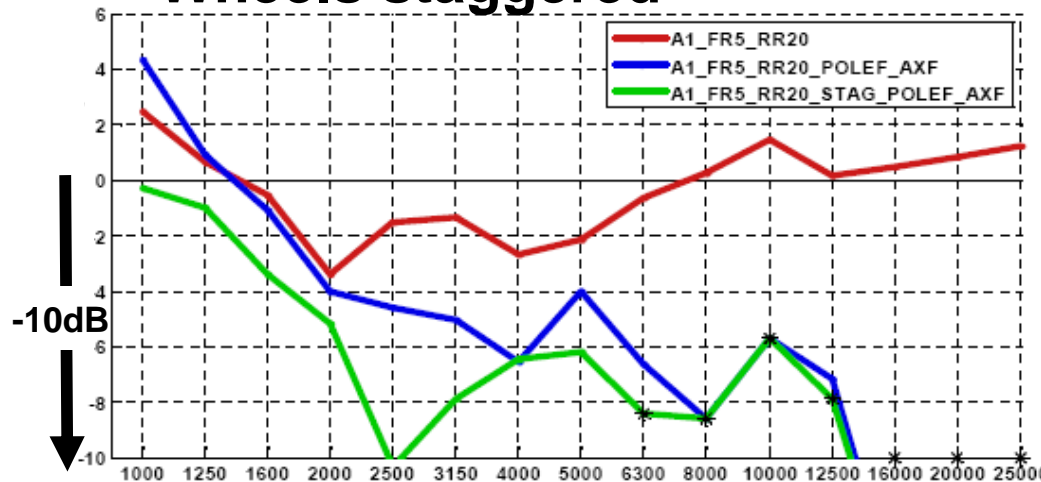

A1 FR5 RR20

POLEF AXF

STAG

Airport Definition

Analysed noise from SAX taking off / landing at a hypothetical runway typical of a large international commercial airport:

SAX airport: 1.0 km - 3.0 km runway - 1.0 km, 0.45 km to side

LHR airport: 0.7 km - 3.9 km runway - 1.0 km, 0.45 km to side

Distances for Take-off/Approach Noise Analyses

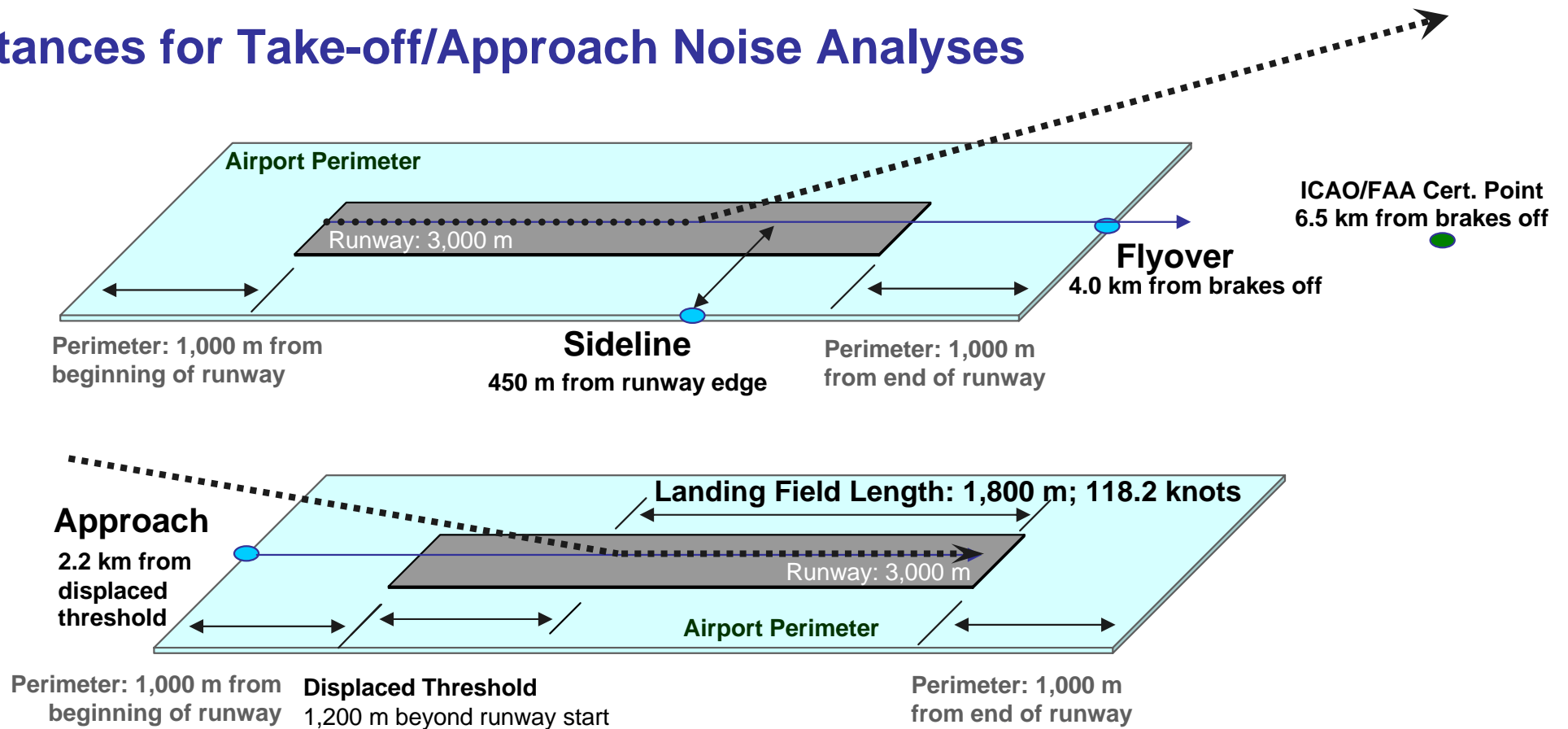

Take-off Noise Predictions - Flyover

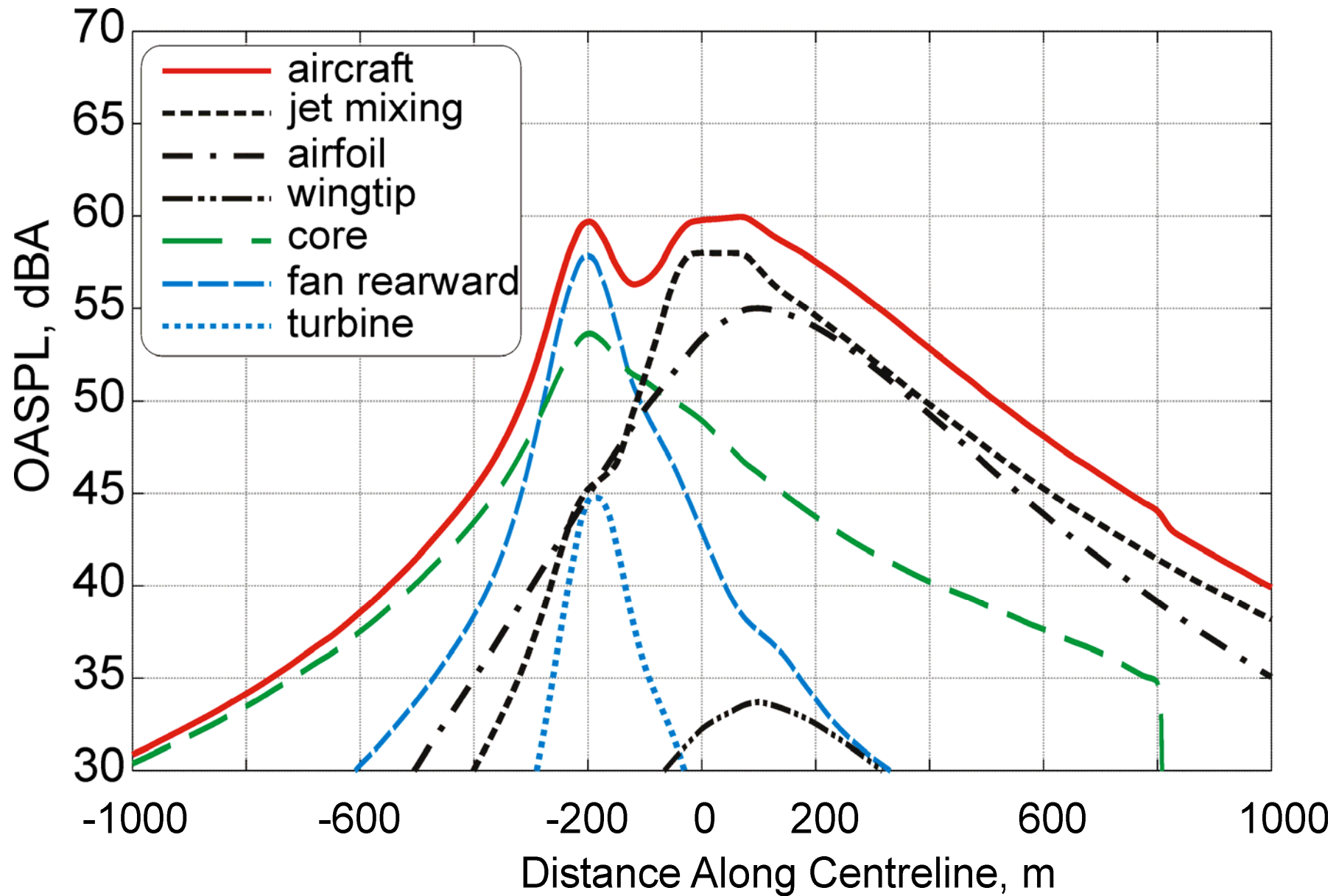

Take-off Noise Predictions - Sideline

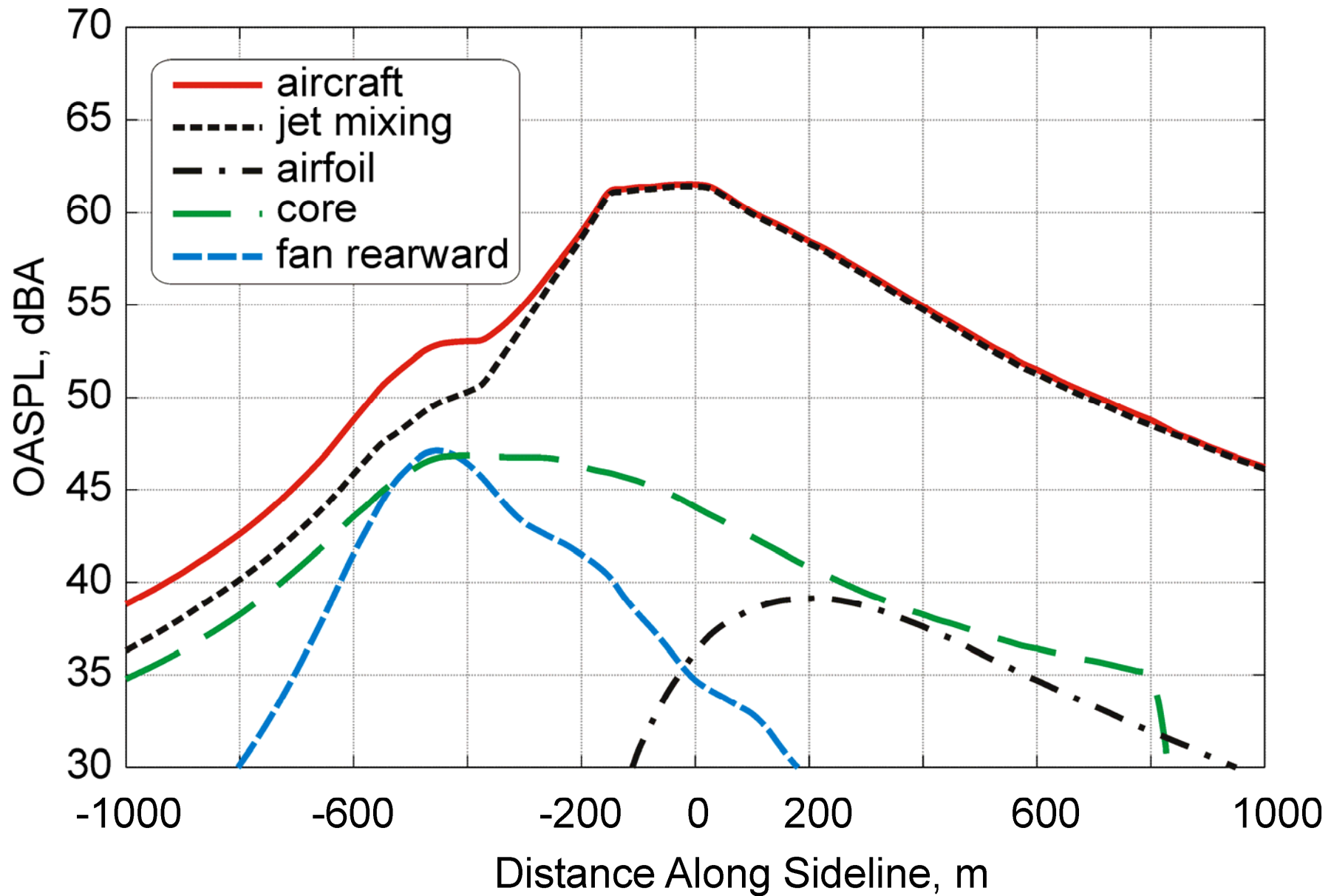

Approach Noise Predictions

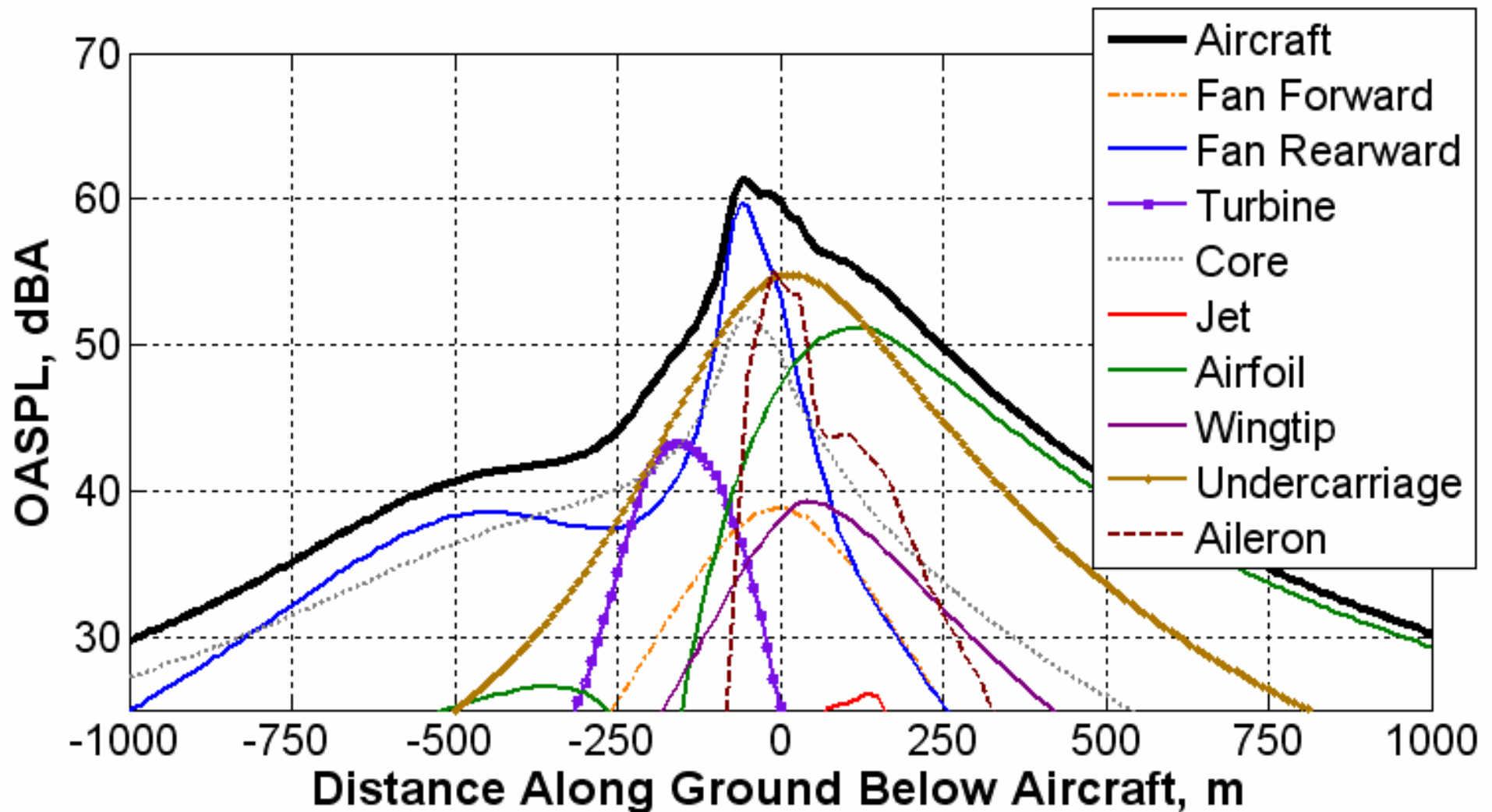

SAX40 EPNL

SAX-40 is predicted to achieve a step-change in noise from existing fleet.

SAX-40 EPNL estimates:

- **Sideline: 68.8 EPNdB**
- **Takeoff: 69.2 EPNdB**
- **Approach: 71.9 EPNdB**

Used ICAO certification points.

Take-off, climb and approach analysed in papers:

- **AIAA 2007-0451**
- **AIAA 2007-0456**

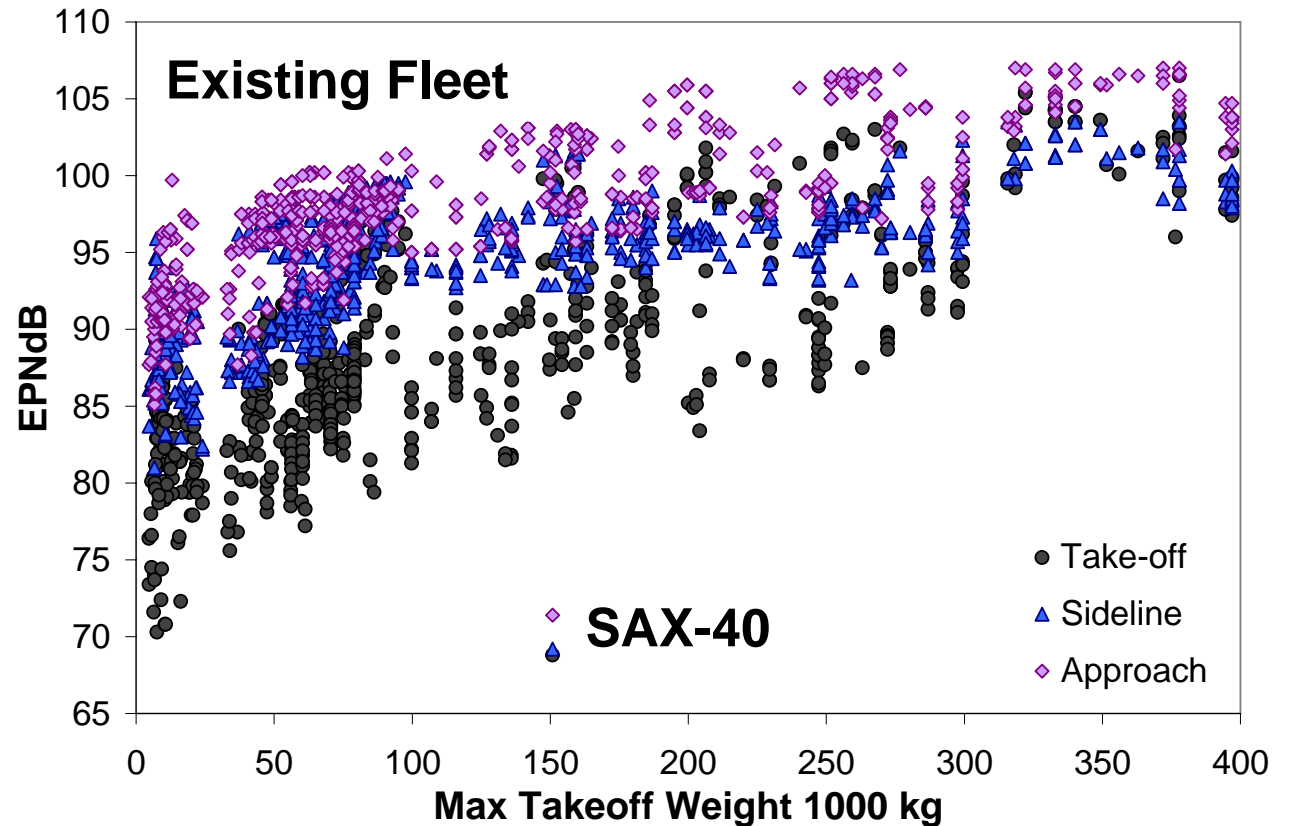

Cumulative noise is 75 cumulative EPNdB below ICAO Chapter 4 requirement of 284.5 cumulative EPNdB.

Enabling Technologies for Low-Fuel burn

	passenger miles per gallon
SAX-40	~124
Toyota Prius Hybrid Car	~120 with 2 people
Boeing 777	86 - 101
Boeing 707	46 - 58

Low fuel burn is achieved by

- a very efficient aircraft based on the 'flying wing' or Blended-Wing-Body, with a lift to drag ratio of 25 to 1 (some 10% higher than other designs)
- the aircraft wake is further reduced by ingesting the air near the aircraft into the engines
- the engine exit nozzle is adjusted for optimum efficiency throughout cruise

Requirements for Viability

Market viability.

Societal acceptance.

Aircraft certification.

Technical challenges:

- **Propulsion system / airframe integration (inlet distortion noise, forced vibration issues, gear-drive, etc.).**
- **Structural analysis and manufacturability of non-circular pressure vessel.**
- **Mechanical design of thrust vectoring and variable area nozzle**
- **Low speed aerodynamic performance.**
- **Cabin layout with assessment of interior vibration and noise.**
- **Maintenance considerations.**

Conclusions

SAX40 is designed to carry 215 passengers 5000nm at a cruise Mach number of 0.8

- Predicted noise is maximum of 62 dBA outside the airfield perimeter
- Predicted fuel burn 124 passenger-miles/US gallon
- The 'Silent' Aircraft conceptual design has relied on
 - a novel airframe (leading-edge carving) and engine architecture
 - advances in design methodology, integrating airframe and engine design with optimised operations
 - methods to predict and measure noise
- Low noise is not due to a single design feature
 - due to the integration of many disciplines into the design and operation of a noise-minimising aircraft
- There are a number of technical challenges to be overcome before an aircraft like SAX40 could become a reality
- The project has identified these challenges and the research required
- Some technologies and approaches could be used nearer term
 - variable area nozzles, power optimised take-off, liner optimisation

Acknowledgement - Cambridge/MIT Silent Aircraft Team

V. Madani - Inlet design
A. Plas - Effect of boundary layer ingestion on fuel burn
M. Sargeant - Inlet/airframe integration / 3D Airframe CFD

A. Faszler - Aerofoil Trailing Edge

P. Shah, D. Mobed - Engine air brake
T. Law - Exhaust nozzle design
S. Thomas - Vectored thrust / Aircraft control

E. de la Rosa Blanco - In-depth engine analysis/design
D. Crichton - Fan & variable nozzle design

J. Hileman - 3D Aero Design
A. Jones - Optimization

Former Members:

A. Diedrich - SAX10 platform
P. Freuler - Inlet Design
D. Tan - Noise propagation modeling
G. Theis - Economics
N. Sizov - Operations
R. Morimoto - Economics
C. Hope - Economics
K. Sakaliyski - Drag Rudders / Spoilers
P. Collins - KIC Manager

A. Quayle - Undercarriage

A. Agarwal - Acoustic Shielding

High-Lift:
C. Andreou - Slats / Suction
A. Townsend - L.E. Rot Cylinder

Y. Liu - Scattering Effects:
Surface finish

H.-C. Shin - Acoustic Measurements
& Phased Array Design

Faculty: A. Dowling, E. Greitzer, H Babinsky, P. Belobaba,
J.-P. Clarke, M. Drela, C. Hall, W. Graham, T. Hynes, K. Polenske,
Z. Spakovszky, I. Waitz, K. Willcox, L. Xu

R. Tam - Economics
T. Reynolds - Operations

Chief Engineers: J. Hileman and Z. Spakovszky

Acknowledgement - Partners

About 30 partners including

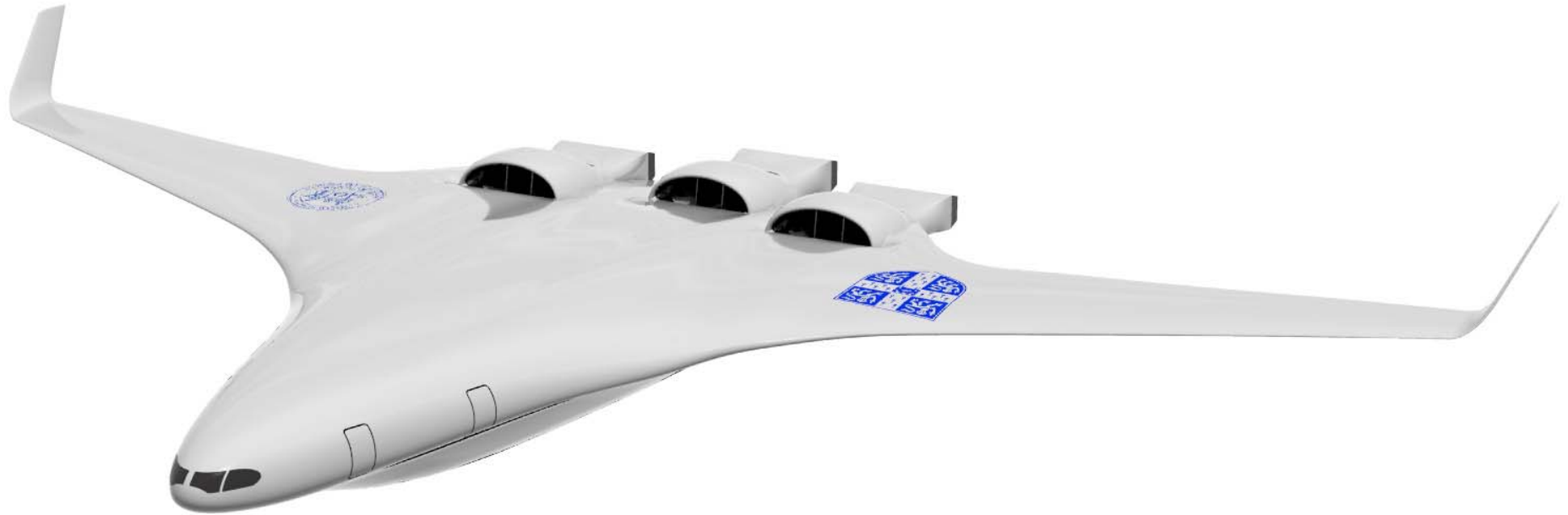

Boeing, Rolls-Royce, NASA, NATS, CAA, airline and airport operators, HACAN, B&K, Lochard, Cranfield University

SAX 40

