

Presented by

Daniel Reckzeh
Aerodynamics Domain
Airbus

Flying Community Friendly – The Role of High-Lift Aerodynamics

Design concepts & solutions for the future



The high-lift contribution ...

... for reduced fuel burn & emissions:

- **by light systems & structure**
 - ▶ **Lightweight solutions** for classical systems
 - ▶ **Enhanced high-lift performance** to downsize the required moveables system
- **by multi-purpose devices**
 - ▶ Cruise variable camber flaps with differential flap setting
 - to **enhance cruise flight performance**
 - to provide **lift control**
- **by novel efficient engines**
 - ▶ Novel leading edge moveables to allow **close coupled integration of ultra-high-bypass engines**
- **by laminar flow wings**
 - ▶ Novel Leading edge moveables **enabling laminar flow on wing**
 - ▶ enhanced trailing edge moveables to allow **slatless leading edge**
 - ▶ Cruise variable camber flaps for **shock control**



The high-lift contribution ...

... for reduced noise impact:

- „by performance“
 - ▶ Enhanced high-lift performance
 - for **steep approach**
 - for **steep climb-out** or **reduced engine power**
- „by design“
 - ▶ **Suppression of source noise** on the high-lift system and landing gear
 - ▶ High-lift solutions for configurations with **noise shielding**

... for increased airport capacity: (i.e. more efficient use of given infrastructure)

- **by increase of take-off / landing frequencies**
 - ▶ **climb-out & glide path flexibility**
 - ▶ **wake vortex prediction & control**



The high-lift contribution ...

... for improved economic performance

(i.e. reduced cost & time to market for novel efficient aircraft):

- **Earlier convergence & fidelity** of assessment of the configuration by the use of

- ▶ Modern parametric CAD tools allowing close coupled multidisciplinary work
- ▶ High-fidelity 3D CFD
- ▶ High Reynolds-number windtunnel testing
- ▶ Rapid prototyping windtunnel models with minimum lead time

- **... leading to**
 - ▶ reduction of lead time
 - ▶ minimizing uncertainties and resulting unnecessary margins

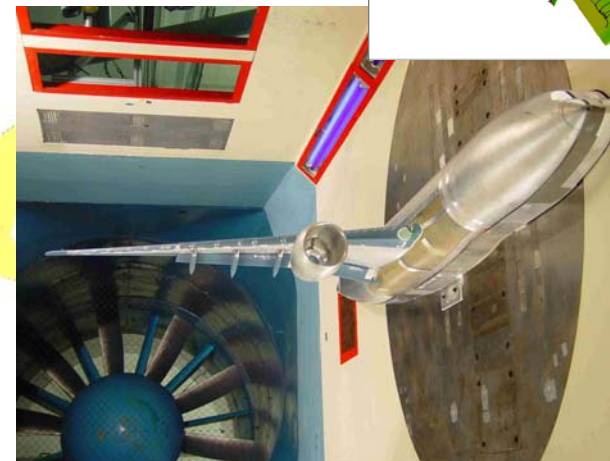
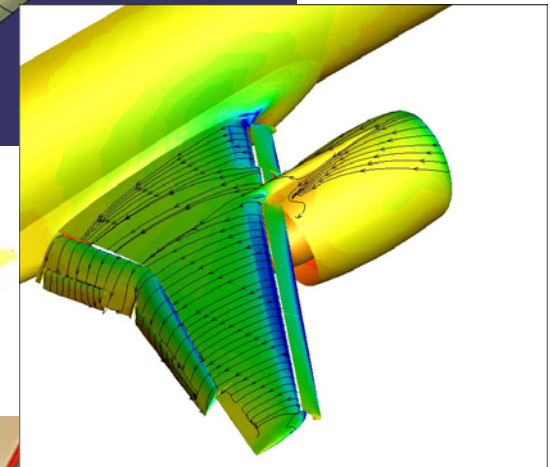
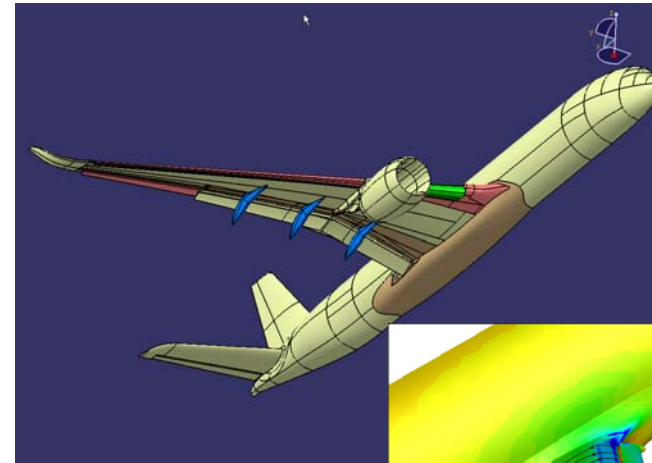

A) Significant evolution of classical configuration

Main elements:

- ***High- / Low Speed Integrated wing design***
- ***New Leading edge concepts***
- ***New Trailing edge concepts***
- ***Passive flow control***
- ***New devices concepts***
- ***Airframe source noise optimised design***
- ***Wake vortex optimised design***

Example: Advanced Trailing Edge Control Surfaces

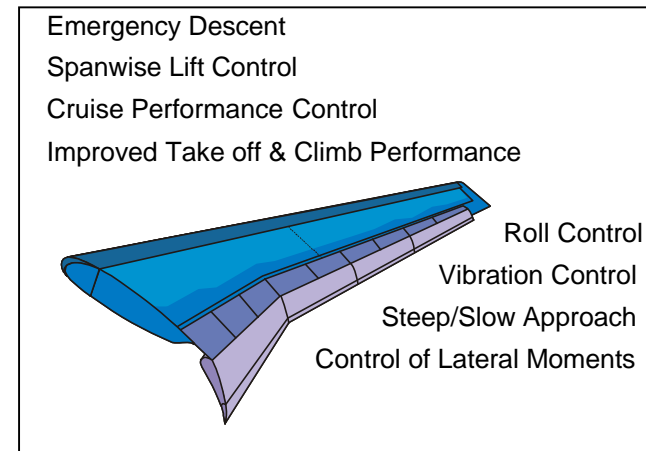

Example: Source noise prediction & suppression

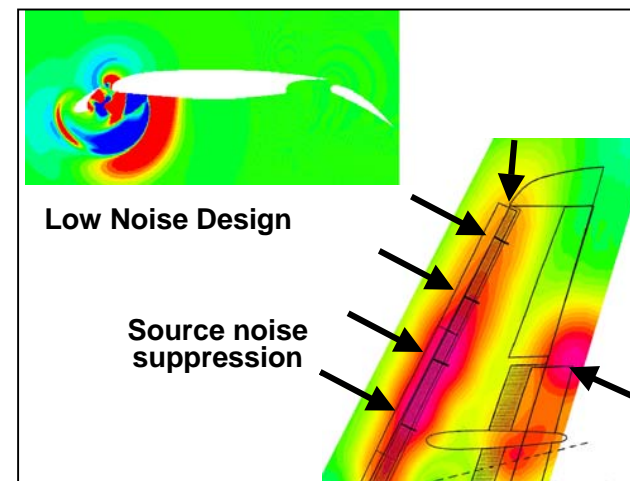

B) 'Smart' configuration with flow control features

Main elements:

- *Improved A/C configuration*
- *Highly advanced high-lift system*
- *Laminar flow control wing (Active or passive)*
- *Effective use of active high-lift flow control*
- *Aeroacoustics optimised airframe layout "by design"*
- *Integration of UHBR- or open rotor engines*
- *Optimised (deliberate) interaction between engines and high lift system*
- *Best compromise between extreme high lift capabilities and system consequences*

Example: Flow control

HICON studies
(TU Braunschweig)

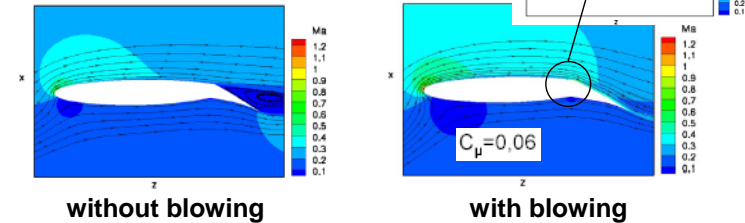

Example: Smart high-lift devices

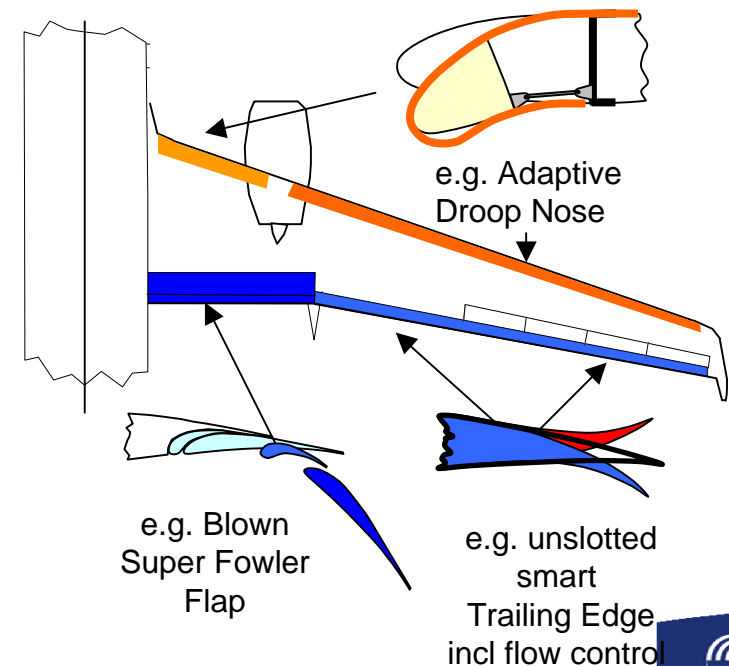

C) Novel configurations

Main elements:

- ***New configuration***
- ***Aeroacoustics optimised airframe layout “by configuration”***
 - ▶ Novel engine integration concepts
 - ▶ Novel low-noise High-lift concepts
- ***Highly advanced high-lift systems***
 - ▶ ‘Active flow control on wing & high-lift devices

Example: Unconventional configurations



Design solutions – A350XWB

A multi-purpose trailing edge system



The A d a p t i v e D r o p p e d H i n g e F l a p

▶ Enhanced low speed aero performance

▶ Low complexity flap kinematics

▶ Cruise Variable Camber functionality and differential flap setting

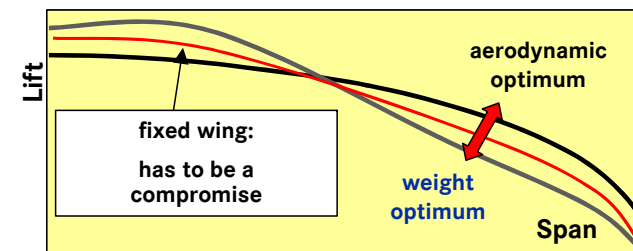
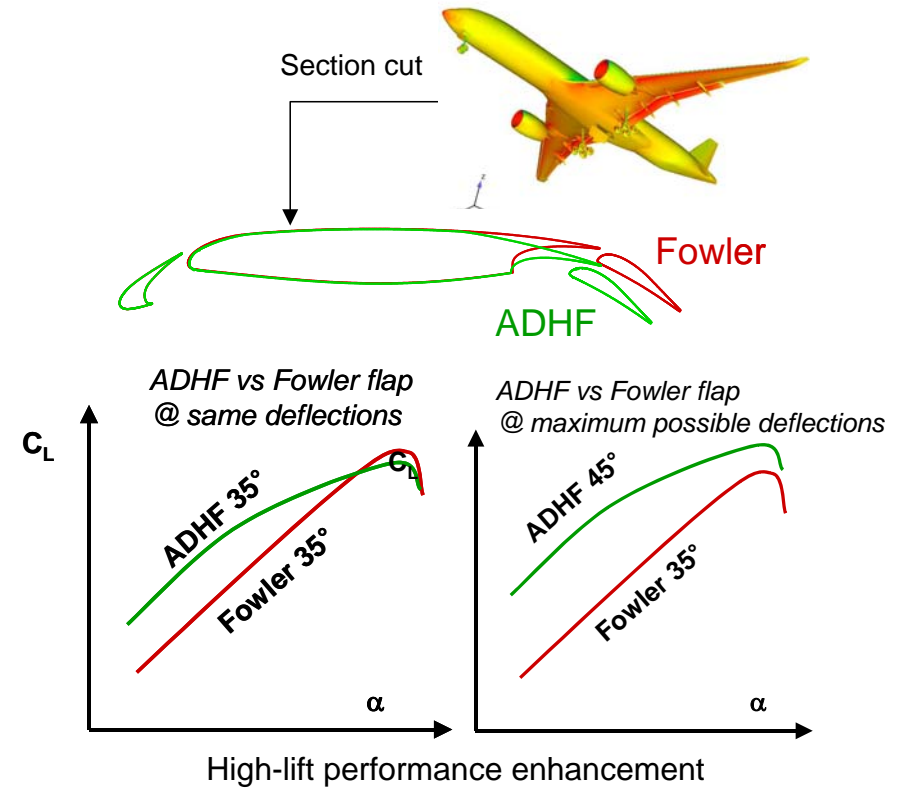

Design solutions – A350XWB Take off performance & Engine integration



- **Droop Nose Device & Sealed Slats**

- ▶ Significant take-off drag improvement optimised A380 style droop nose device and slats with a sealed take-off position
- ▶ Advanced droop nose concepts and detailed improvements

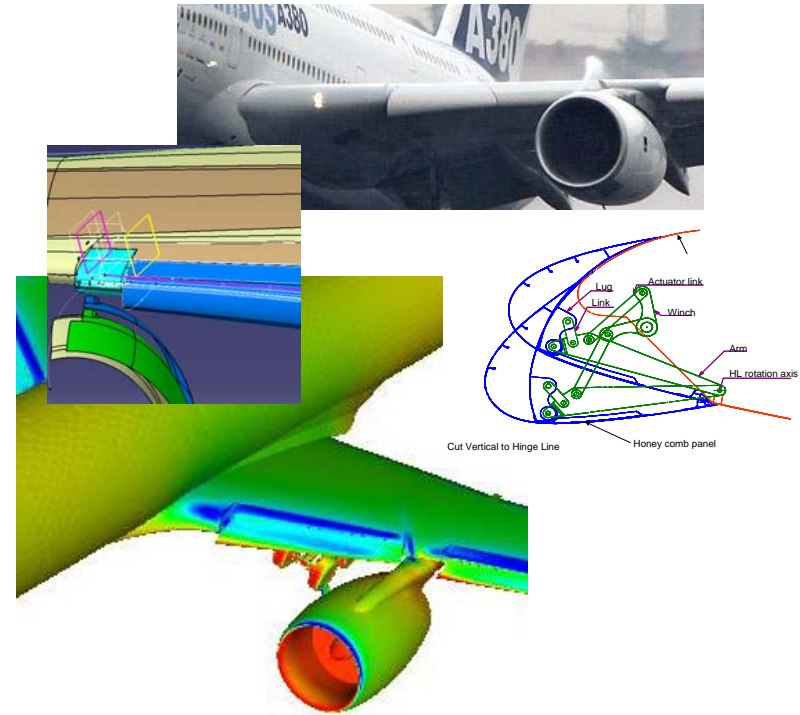

- **Integration of modern Very High Bypass Ratio engines**

- ▶ Closed coupled VHBR engines act as major constraint for the integration of the leading edge moveables
- ▶ Significant shortfall in performance can be triggered from premature flow separation the nacelle/pylon junction area,
 - i.e. careful design optimisation is required
- ▶ Droop Nose device allows a sufficient protection without the need of complex local treatments
- ▶ Strakes / vortex generators provide a further further local improvement of the flow conditions

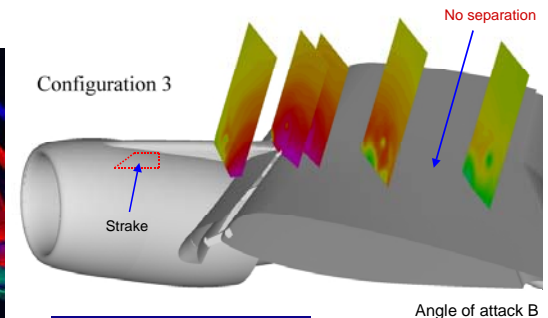
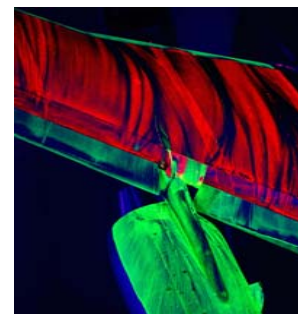

Design solutions – future devices concepts

Fully integrated trailing edge concept

Several adaptive trailing edge concepts developed in past R&T ... however, heavy & complex solutions due to additional element at the fowler flap

The HICON approach: Full multi-purpose use of the high lift element

→ The “Slotted Camber Tab” (SCT)

- Provide low complexity / weight flap kinematics
- Avoid disadvantages of Dropped Hinge Flaps:
- Multi-purpose HL system use in cruise
- HL system used for roll control & airbrake

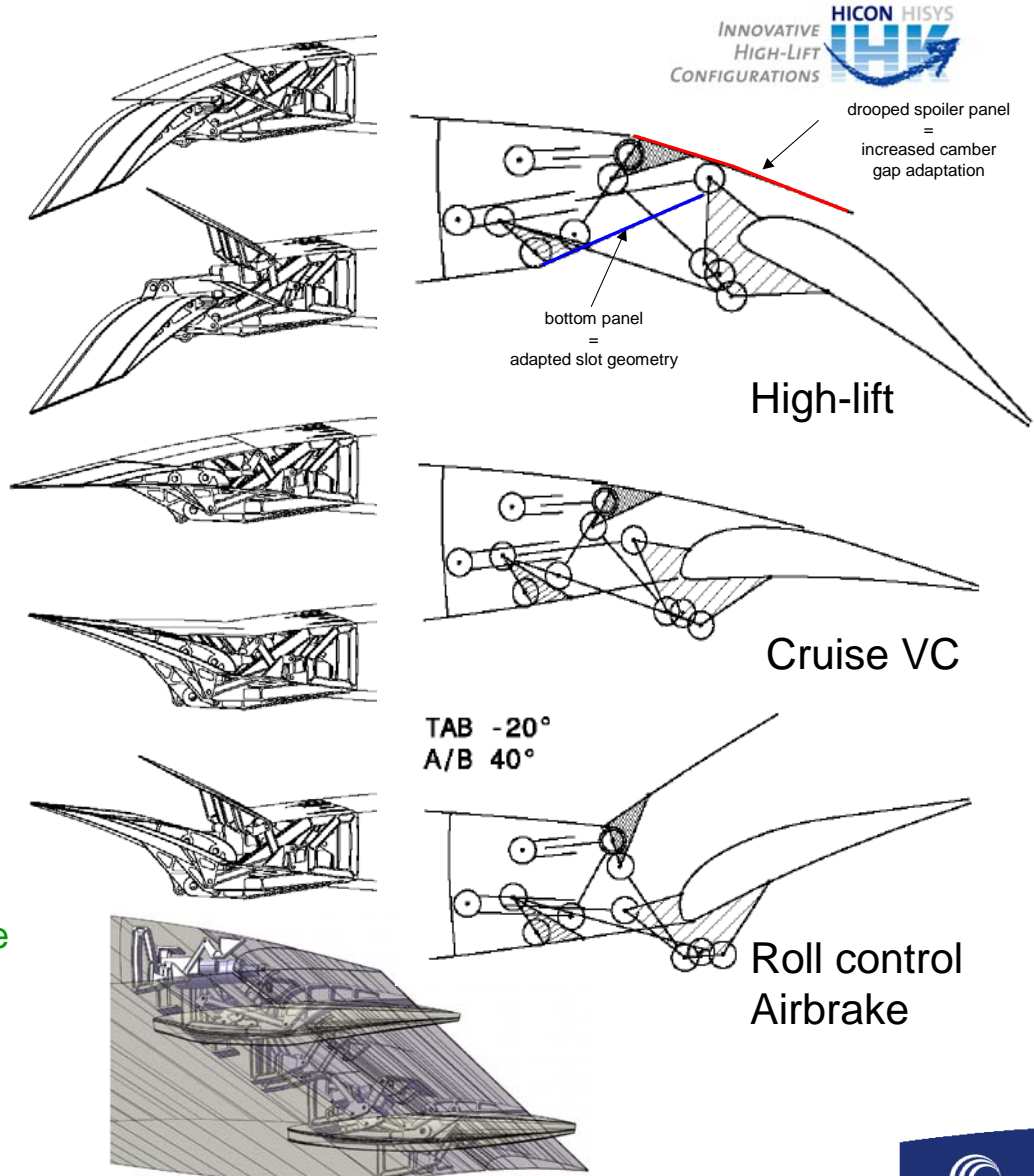

Design solutions – future devices concepts

Steep approach

- Steep approach flight is seen as a major opportunity to **alleviate community noise impact**
- Devices which create drag without loss of lift are most efficient
 - ▶ Add-on devices are effective but create unwanted weight effect & integration challenge
 - ... which may even outbalance the overall benefit
- The aim is to design additional functionality into the baseline high-lift & controls concept
 - ▶ ... to provide steep approach performance as „fall-off“
 - ▶ ... while enabling low source noise of the devices
- Novel spoiler concepts and low complex add-on devices are being developed in this context

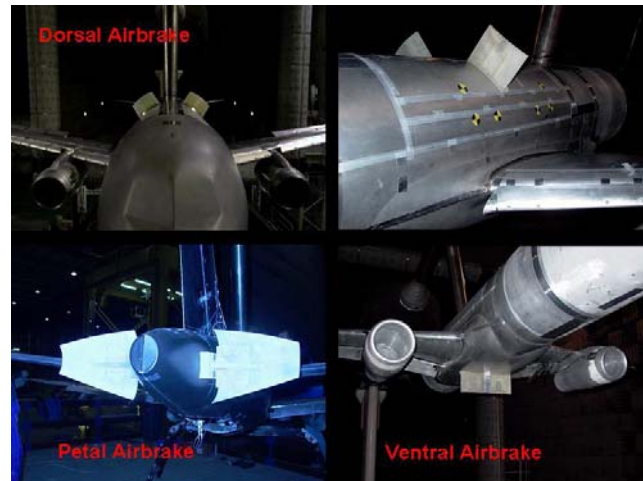
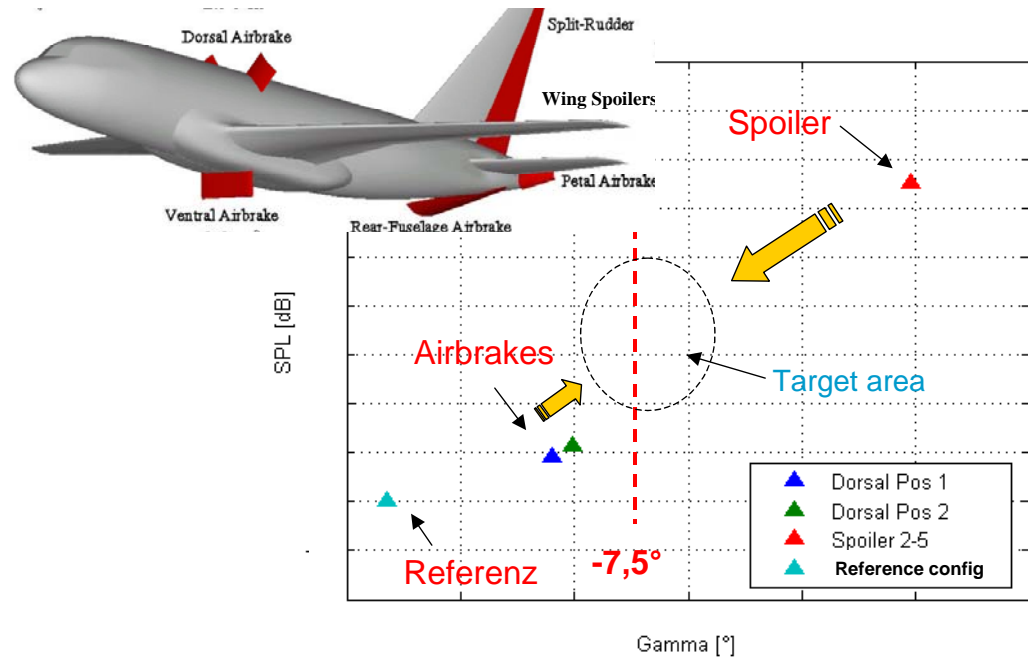

A318 at London City Airport

→ Spoiler used for steep approach configuration

Design solutions – future devices concepts

High-Lift solutions enabling a laminar wing

- „Laminar wing tailored“ **Leading edge devices**

- ▶ to provide sufficient maximum lift performance despite sharp laminar wing nose
 - avoidance of significant oversizing of the cruise wing to meet high-lift performance
- ▶ **Advanced Krüger-Slat**
 - enabling laminar flow on wing upper surface
 - Functional integration of high-lift and shielding function

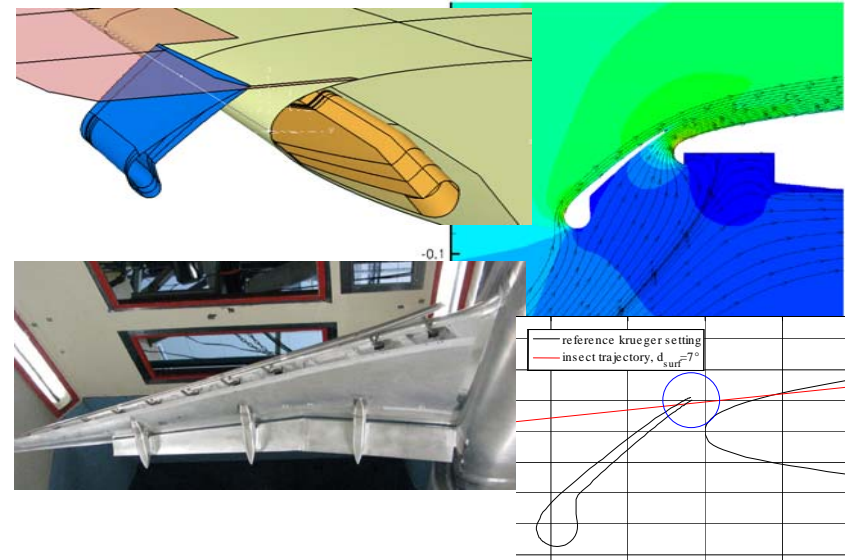

- **Variable Camber Trailing edge devices**

- ▶ to provide control of cruise pressure distribution shock location → maximise operating range with laminar flow
- ▶ **Adaptive Dropped Hinge Flap (A350)**
- ▶ **Advanced Tracked Flap**
 - Combining advantages of a tracked fowler flap with variable camber function

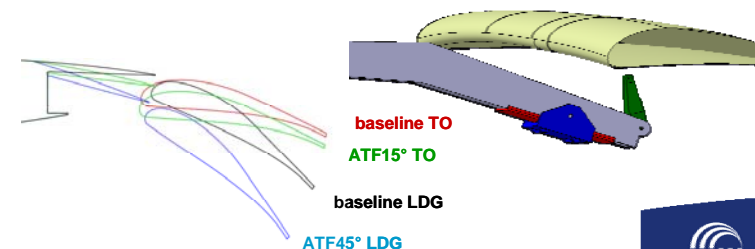
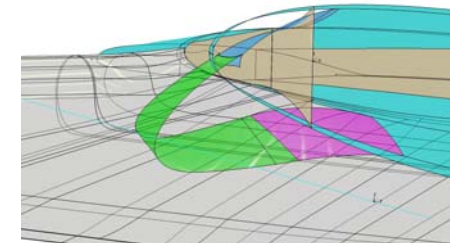

Design solutions – Active Low Speed Flow Control

- **Active flow control for low speed applications**
 - ▶ To **enhance** the performance of passive high-lift systems
 - ▶ To „**repair**“ critical areas on the wing
 - ▶ To fully **replace** classical high-lift systems
 - ▶ ... with the aim of flow control solutions being **more effective or lighter** than passive mechanical high-lift solutions
- *In recent R&T (e.g. JTI SFWA, AVERT and Lufo4/Aeronext) the convergence of suitable solutions is pursued with the aim to lead to selected multidisciplinary optimised and aircraft qualified applications*

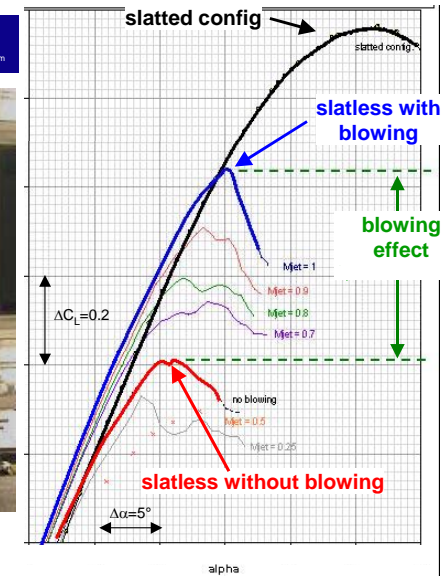
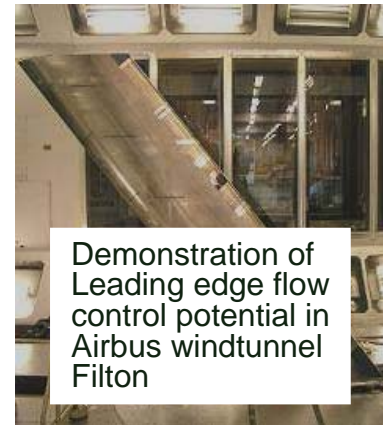

The diagram shows a trailing edge flow control system with components: 'pulsierender Jet', 'Aktuator', 'Pulsweite', 'Sensoren', and 'Extremwertregler'. A graph shows a pulse signal. Below is a photograph of the system on a wing model with a white box overlay.

Demonstration of Trailing edge flow control potential on industrial wing configuration in Airbus windtunnel Bremen

WT Test in LSWT-B with HIREX 1:12 model

Development of CFD prediction capability

Advanced tools – Design tools & CFD

- **Parametric shape design tools**

- ▶ → *significant multidisciplinary turn around time improvement and shape quality control*

- **Integrated CFD toolchain**

- ▶ → *turn around time and optimisation depth improvement by „on-line shapes assessment“*

- **3D CFD**

- ▶ → *design maturity improvement due to analysis of complex flow features and limiting effects*

- **Computational aeroacoustics**

- ▶ → *awareness of source noise optimisation potential*

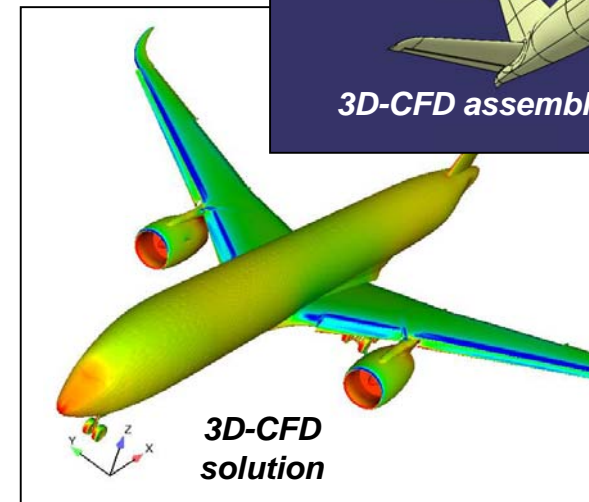
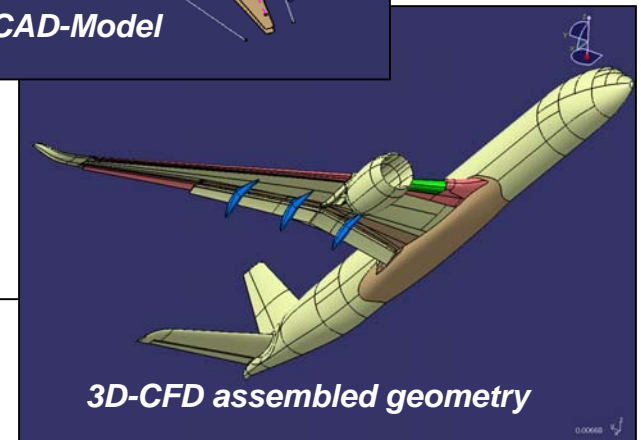
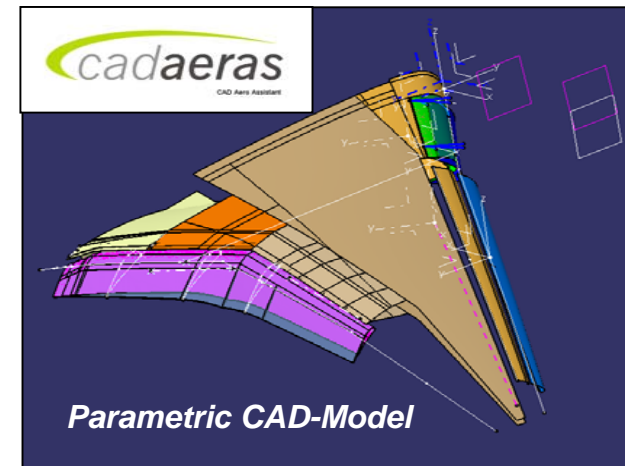

Advanced tools – Windtunnel testing

- **Extensive low Reynolds number testing (Airbus Windtunnels Bremen & Filton)**

- ▶ → *design concept variation & convergence*

- **Medium Reynolds numbers testing (Onera F1, DNW)**

- ▶ → *detailed design convergence and comprehensive data generation*

- **High Reynolds number testing in cryogenic conditions (ETW)**

- ▶ → *reduction of uncertainties and avoidance of unnecessary margins*

Rapid prototyping model concept

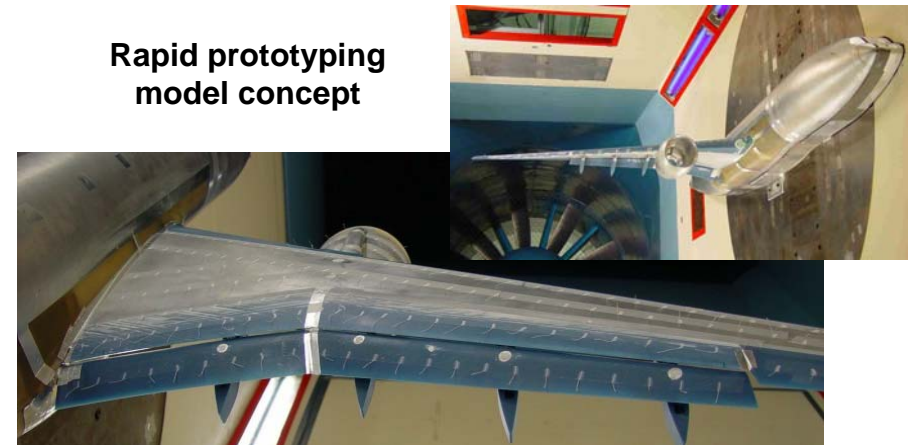

High Reynolds number testing in ETW



Low Reynolds number testing including acoustic array

Where do we want (& need) to be ? – Expected key outputs from High-Lift R&T

Short Term

- Multidisciplinary feasibility and potential of **advanced leading & trailing edge concepts** proven
- Improved capability on high/-low speed **integrated design**
- Basic understanding of airframe noise drivers and first concepts for **noise reduction** available for application
- **CAA-codes and experimental acoustics** available in design process
- **Flight-Reynolds-testing** further established as design verification tool

Mid Term

- Novel **smart solutions** for advanced leading & trailing edge concepts available
- **Design to noise capability** and new solutions for noise reduction available
- **Integrated high-/low-speed design** process fully established
- **3D-CFD and flight-Reynolds-verification** established as major design verification tools

Long Term

- Fully integrated **multidisciplinary 3D design process** for high-lift wing already in early concept phase established
- **Integrated 3D-CFD&CAA** tools established as major design & verification tools
- **Smart High-lift solutions** for extreme noise and traffic requirements available
- High-lift solutions for **novel configurations** beyond 2020 established

The role of high-lift aerodynamics - Conclusion

- High-Lift Aerodynamics is a key contributor to enable future aircraft to show significant improvements in
 - ▶ **Environmental impact (emissions)**
 - with light & efficient multifunctional high-lift systems
 - ▶ **Community noise**
 - with optimised flight performance as well as source noise optimised configurations
 - ▶ **Economic performance**
 - with weight & complexity improved solutions in shorter design cycles
- Airbus aerodynamics is conducting a targeted approach in high-lift R&T to address these future challenges for its product portfolio

© AIRBUS S.A.S. All rights reserved. Confidential and proprietary document.

This document and all information contained herein is the sole property of AIRBUS S.A.S.. No intellectual property rights are granted by the delivery of this document or the disclosure of its content. This document shall not be reproduced or disclosed to a third party without the express written consent of AIRBUS S.A.S. This document and its content shall not be used for any purpose other than that for which it is supplied.

The statements made herein do not constitute an offer. They are based on the mentioned assumptions and are expressed in good faith. Where the supporting grounds for these statements are not shown, AIRBUS S.A.S. will be pleased to explain the basis thereof.

AIRBUS, its logo, A300, A310, A318, A319, A320, A321, A330, A340, A350, A380, A400M are registered trademarks.

